

## Combination of *CryIAc* and *Cry2A* to Produce Resistance against *Helicoverpa armigera* in Cotton

K. S. Bajwa<sup>1,2\*</sup>, M. Azam Ali<sup>1</sup>, A. Q. Rao<sup>1</sup>, A. A. Shahid<sup>1</sup>, and T. Husnain<sup>1</sup>

### ABSTRACT

Genetic manipulation to get desirable characters in cash crops like cotton remains the prime objective of crop biotechnology. To produce transgenic plants resistant against bollworms, newly emerged embryos of MNH-786 cotton variety were transformed with *Agrobacterium tumefaciens* strain LBA4404 harboring the plasmid pKHG4 vector containing *CryIAc+Cry2A* genes under the control of CaMV35S promoter. The integration and expression of these genes were evaluated by PCR, Florescent *In-Situ* Hybridization (FISH), and ELISA, respectively. Out of 700 putative transgenic cotton plants, 10 plants (1.03% transformation efficiency) showed the presence of genes *CryIAc+Cry2A* through PCR analysis. In vitro, insect feeding bioassay was done for estimation of mortality percentage of *Helicoverpa armigera*. Insect mortality rate and morphological characteristics of Bt cotton were analyzed by phenotypic correlation, path coefficient regression and covariance to evaluate the advantage of transgenic technology in numerical terms. Statistical analysis indicated significant positive correlation between insect mortality and cotton seed yield. *Helicoverpa armigera* mortality data produced a directly proportional relation with cotton seed yield. The results of this study support the improvement of cotton defense mechanism against insects and natural competitors through genetic modification.

**Keywords:** Bollworms, Insect mortality, Transgenic cotton.

### INTRODUCTION

Cotton is an essential cash crop of Pakistan (Wendel and Cronn, 2003; Awan *et al.*, 2015). Cotton yield is limited due to several factors globally, and especially in Pakistan, including insects, which contributed 84% of losses in cotton (Awan *et al.*, 2015). Among them, bollworms are a major constraint contributing 30-40% reduction in yield (Abro *et al.*, 2004). Although conventional breeding methods have contributed significantly to cotton improvement, yet they have some limitations for the introduction of new alleles (Keshamma *et al.*, 2008; Khan *et al.*, 2015). Breeding in its current form is insufficient to control insects, the common

problem of most cotton producing countries. To control such losses caused by insect pests, insecticides are widely used every year in developing countries including Pakistan, where 23,157 tons of pesticides were used in 2014-15, costing 134 Million US Dollars. (Economic Survey of Pakistan 2014-15).

Biotechnology has the potential to produce environmentally safe and economically viable new plants with novel genes and new products (Puspito *et al.*, 2015). Cotton biotechnology has tremendous commercial implications in crop improvement. It can change the way cotton has been cultivated so far. In the future, cotton cultivation would certainly be easier, less input dependent, and

<sup>1</sup> Center of Excellence in Molecular Biology, University of the Punjab, Lahore, Pakistan.

<sup>2</sup> Biotechnology Research Institute, Chinese academy of Agricultural Sciences, Cotton Biotechnology lab, Beijing, China.

Corresponding author; e-mail: kamran.molebiol@gmail.com



ecologically more compatible. Therefore, unsurprisingly, transgenic cotton was one of the first genetically modified crops to be released commercially (Christou *et al.*, 2013).

The insecticidal toxins (Cry toxins) of *Bacillus thuringiensis* are being widely used to develop insect resistance in various crops (Ibrahim *et al.*, 2010). Many researchers have used Cry gene(s) such as *CryIAc*, *Cry2A*, *CryIAc+Cry2Ab* or *CryIAc+CryIF* for transformation in different crops especially cotton, which leads to significant reduction in use of chemical insecticide sprays while maintaining population of beneficial insects (Jisha *et al.*, 2013; Ilias *et al.*, 2013; Konecka *et al.*, 2014). Bollworm attack is the main problem encountered in cotton. The American bollworm (*Helicoverpa armigera*) is notorious pest not only in cotton but it feeds upon more than 200 plant species including feed, fiber, oil and fodder crops as well as many horticultural crops (Sharaby and Al Dhafar, 2019). It attacks on cotton plants in almost all parts of the world (Dos Santos *et al.*, 2017), its larvae initially feeds on leaves with boring into flowers, and when bolls emerge, small larvae break into them and move from boll to boll. The development of bolls and lint quality is severely affected (Razmjou *et al.*, 2014).

In the present study, an attempt was made to transform *CryIAc+Cry2A* genes in the MNH-786 local cotton variety of Pakistan to evaluate its effectiveness against *Helicoverpa armigera* and more importantly its relation with yield in quantitative terms. A major reason behind using of MNH-786 local variety for this experiment was its high germination rate under tissue culture conditions and susceptibility to bollworms. That is why combination of double Cry genes was transferred through Agrobacterium mediated transformation method to confer insect-resistance in transgenic cotton plants.

## MATERIALS AND METHODS

### Construction of Expression Vectors Containing *CryIAc+Cry2A* Genes

A fragment containing the *CaMV35S-CryIAc+Cry2A-NOS* in one piece of DNA was cut out from its source plasmid, *pk2Ac* (Sambrook and Russell, 2006; Rashid *et al.*, 2008), by digestion with *HindIII* for *CryIAc* and *HindIII+PmeI* for *Cry2A* and sub-cloned into an intermediate vector. (Rao *et al.*, 2009).

### *Agrobacterium*-Mediated Genetic Transformation

The local cotton variety MNH-786 was selected for transformation owing to its relatively good percentage of germination as compared to other local cotton varieties. The Pakistan local cotton variety MNH-768 displays advantageous morphological characters such as high yield, high CLCuV tolerance, compact and big boll size, but at the same time, it is susceptible to bollworms (Ehsan *et al.*, 2008). The Agrobacterium strain LBA4404 containing the *CryIAc+Cry2A* genes were used for transformation of cotton by the shoot apex method (Johar Campus, 2005; Rao *et al.*, 2011; Rao *et al.*, 2009; Bajwa *et al.*, 2013, Bajwa *et al.*, 2015).

Cotton seeds of the *G. hirsutum* var. MNH 786 were soaked in an autoclaved flask containing optimum amount of water for germination, at 30–37°C for 48 hours in dark. On the day of experiment, the agrobacteria culture, having gene of interest, was harvested and dissolved in MS broth medium. Fresh embryos were isolated from germinating seeds and the apex of the shoot was cut with a sterilized blade (Puspito *et al.*, 2015). Then, the embryos were co-cultivated for 1–2 hours with the Agrobacterium strain LBA4404 containing the *CryIAc+Cry2A* genes. The embryos were dried on sterilized filter paper and

transferred to plates with MS medium for 2–3 days at 28°C in a controlled condition room. After 2–3 days, the embryos were sub cultured in test tubes containing MS medium with kanamycin as a selection marker. Every 15 days, the transgenic cotton plants were sub cultured into new test tubes with fresh MS medium. After 30–45 days of selection on the kanamycin medium, putative transgenic plants were transferred onto shoot (Kinetin 1 mg mL<sup>-1</sup>, Indole Acetic Acid 1 mg mL<sup>-1</sup>) and root regeneration media (Indole butyric acid 1 mg mL<sup>-1</sup>, B5 vitamins 1 mg mL<sup>-1</sup>) without kanamycin. After two months, the healthy putative transgenic cotton plants were shifted from MS medium tubes to pots containing autoclaved loamy soil. The stable, putative transgenic cotton plants were subjected to molecular analysis after 15–20 days of acclimatization in pots conditions (Bajwa *et al.*, 2013, Bajwa *et al.*, 2015).

#### Detection of *CryIAc+Cry2A* Genes

Newly emerged leaves from putative transgenic cotton plants containing *CryIAc+Cry2A* genes were subjected to genomic DNA extraction along with control non transgenic cotton plants as done by Bajwa *et al.* (2015). Presence of the *CryIAc+Cry2A* transgenes in putative transgenic cotton plants were confirmed by the amplification of a 585 bp PCR product for (*CryIAc+Cry2A*) using gene specific primers. The primer sequences used for the detection of *CryIAc+Cry2A* were 5'-AGATTACCCAGTTCAGAT-3' and 5'-GTTCCCGAAGGACTTTCTAT-3'. The amplified PCR fragments were resolved on 1.5% agarose gel and observed under UV light.

#### Quantification of *CryIAc, Cry2A* Proteins through ELISA

To quantify the expression of the *CryIAc, Cry2A* proteins, Enzyme Linked

Immunosorbent Assays (ELISA) were done both temporally as well as spatially according to an established protocol (de Oliveira *et al.*, 2016) using Enviroligix Kit (Cat # 051). Newly emerged leaves of transgenic cotton plants were ground to a fine powder in liquid nitrogen for protein extraction to be used to carry out ELISA. After completing the prescribed protocol, ELISA plates (Costarvinyl, Cambridge, MA, USA) were subjected to an ELISA microplate reader (BIO-RAD Model 550; USA) for the calculation of protein quantity at 450 nm.

#### Integration of Transgenes

Integration of *CryIAc+Cry2A* was confirmed by Fluorescence *In Situ* Hybridisation (FISH) and its karyotyping was done according to standard protocol as described by Ali *et al.* (2016). To prepare probe of *CryIAc, Cry2A* genes, PCR products were run on 1% agarose gel and eluted by using DNA elution Kit (Fermentas K0513) according to the manufacturer's protocol. The eluted PCR product was labeled with the Fluorescein. ULS® Labeling Kit (Fermentas K0641). To prepare slides, seeds of selected transgenic cotton plants were sown in dark under culture room condition overnight. After emerging, root tips were collected (1-2 cm long) and washed in distilled water. Root tips were fixed overnight in fixative. The next day, the fixative was removed, and the meristematic portion of roots was cut (1-2 mm) and incubated in an enzyme solution (Pectolyase and Cellulase) at 37°C for 4-5 hours for cotton roots. Chromosomes were spread on microscopic glass slides with a drop of fixative and air dried. Slides were observed by phase contrast microscopy (Carl Zeiss AXIO Sr. 3517001415) and selected for FISH. The slides were dehydrated successively in 70, 95, and 100% ethanol for 5 minutes in each solution respectively and stored at room temperature. After the preparation of slides, 100 uL of an RNase solution (100X dilution of 1% RNase A) was added to each slide and



incubated in a wet chamber for 45-60 minutes at 37°C. After incubation, the slides were washed in 2X SSC at room temperature followed by dehydration in 70, 95, and 100% ethanol, respectively. Later, 20-30 ng of probe DNA was added to hybridization solution and denatured at 80-90°C for 10 minutes followed by quick chilling on ice. Then, 35 µL of it was spread on each slide and air dried. The chromosomes were denatured at 80°C for 10 minutes in water bath in 2X SSC. The slides were incubated at 37°C for 18 hours in wet chamber. The next day, the slides were washed with 2X SSC at 42°C and then with 4X SSC at 42°C. Propidium iodide (1 mg mL<sup>-1</sup>) was diluted 2,000X on ice and 500 µL was added on each slide and incubated for 5 minutes at room temperature. Slides were washed with 3 mL of 1X PBS and stored in the dark at 4°C. Slides were used for the detection of fluorescent signals by Fluorescent microscope (Carl Zeiss AXIO 100) using appropriate filter set. The fluorescence signal was captured with a CCD camera and analyzed with the Genus 3.7 software provided by Cytovision Applied Imaging Systems. The karyotyping was done using the same software package and the positions of the *CryIac*, *Cry2A* genes were determined.

### ***In vitro* Insect-Feeding Bioassay of Transgenic Cotton Plants**

To test the efficacy of the endotoxins in transgenic cotton plants against *Heliothis* larvae, an insect bioassay comparing the effect of transgenic and control cotton plants was done. Three 2<sup>nd</sup> instars larvae were allowed to feed on fresh leaves both from transgenic and control plants in T1 generation in a Petri dish. At T2 generations, transgenic and control cotton plants were subjected to insect bioassay at greenhouse. Insect mortality data (the number of dead larvae and the total number of larvae) was recorded every three days (Bakhsh *et al.*, 2009; Puspito *et al.*, 2015). Mortality rates were calculated as follow;

$$\% \text{Mortality} = \frac{\text{No of Deat Larvae}}{\text{Total No of Larvea}} \times 100$$

### **Statistical Analysis**

Randomized complete block design was used for this experiment with three replications of each material with plant to plant distance 9 cm and row to row 12 cm. Data was collected from three tagged plants from each replication for morphological characteristics such as Plant Height (PH) (cm), Boll Weight (BW), No. of Nodes/Plant (NPP), No. of Squares/plant (SPP), No. of Flowers/Plant (FPP), No. of Bolls/Plant (BPP) and Mortality (%). Covariance among different events of transgenic cotton plants of local cotton variety MNH-786 was calculated with the help of Statistix 8.1 (Ahmad *et al.*, 2012). SAS code v 9.4 software was used for correlation analysis and Ms XL stat was used for coefficient regression analysis of all events of transgenic cotton variety. Diagrammatic illustrations were developed by Smart Draw Ci v 22.0.1.

## **RESULTS**

### **Cloning and Stable Genetic Transformation of Insect and Herbicide Resistant Genes**

A binary construct harboring the *CryIac+Cry2A* genes under CaMV 35S promoter and the plant selectable marker *neomycin phosphotransferase* (*nptII*) gene was developed with specific HindIII double digestion sites. These constructs were used for genetic transformation of cotton.

### **Genetic Transformation of *CryIac+Cry2A* Genes**

*Agrobacterium*-mediated shoot apex method was used for the transformation of

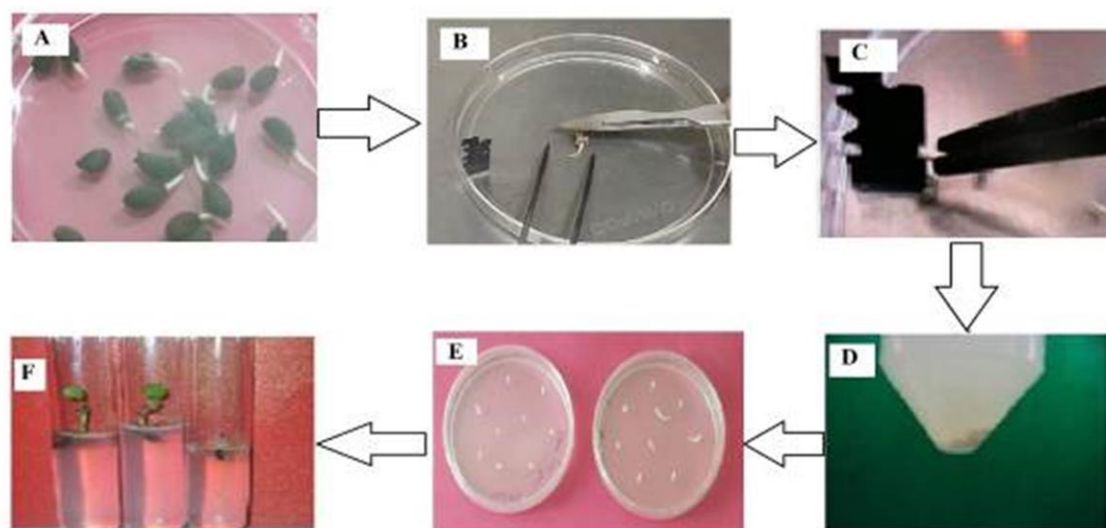

**Figure 1.** Complete Protocol of *Agrobacterium* Mediated Transformation in cotton plant embryos: (A) Germinated cotton seeds, (B) Isolation of cotton embryos, (C) Injury to Cotton embryos, (D) Co-cultivation of cotton embryos in MS broth containing *Agrobacterium* harboring *CryIAc+Cry2A* genes, (E) Implantation of *Agrobacterium* inoculated cotton embryos on petri-plates containing MS medium, (F) Transgenic cotton plants shifted to test tubes containing MS medium with kanamycin (selection marker).

*CryIAc+Cry2A* genes into the genome of local cotton variety MNH-786. A total of 9,000 embryos were used for transformation with the *CryIAc+Cry2A* genes. Selection was done on MS medium containing 50 mg mL<sup>-1</sup> kanamycin (Figure 1). A total of 93 putative transgenic cotton plants were obtained with a transformation efficiency of 1.03% calculated based on plant survival and 0.1% on basis of confirmation gene integration in transgenic cotton plants [Figure 1 (A-F)].

#### Molecular Detection of Putative Transformed Cotton Plants

Presence of the *CryIAc+Cry2A* transgenes in transgenic cotton plants was detected by PCR. The 585 bp fragments of *CryIAc+Cry2A* (Figure 2) were amplified with gene-specific primers. Nine out of 20 putative transgenic cotton plants were found to generate the two PCR products, namely,

ins-786-1, ins-786-3, ins-786-4, ins-786-5, ins-786-6, ins-786-7, ins-786-8, ins-786-9, and ins-786-10. No amplification was observed in the negative control (MNH-786).

#### Quantification of *CryIAc* and *Cry2A* Protein

The transgenic cotton plants confirmed through the PCR assay were subjected to ELISA for quantification of transgenic proteins. A total of nine positively amplified transgenic cotton plants showed variable transgene protein through ELISA, while no expression of protein was observed in the negative control plants (Figure 3).

#### Genetic Integration of Transgenes

Fluorescent *In Situ* Hybridisation (FISH) was used for the determination of copy

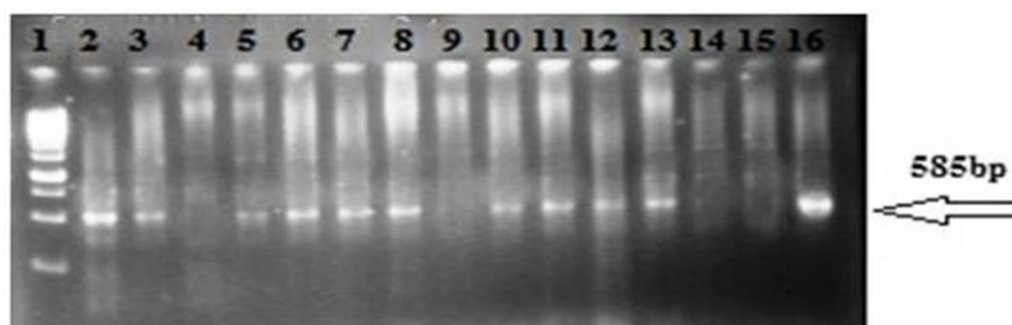

**Figure 2.** PCR amplification of transgenic cotton plants with *Cry1Ac+Cry2A* genes: (Lane 1) 1 kb DNA marker, (Lane 2-14) Transgenic cotton plants, (Lane 15) Negative Control, (Lane 16) Positive control (plasmid).

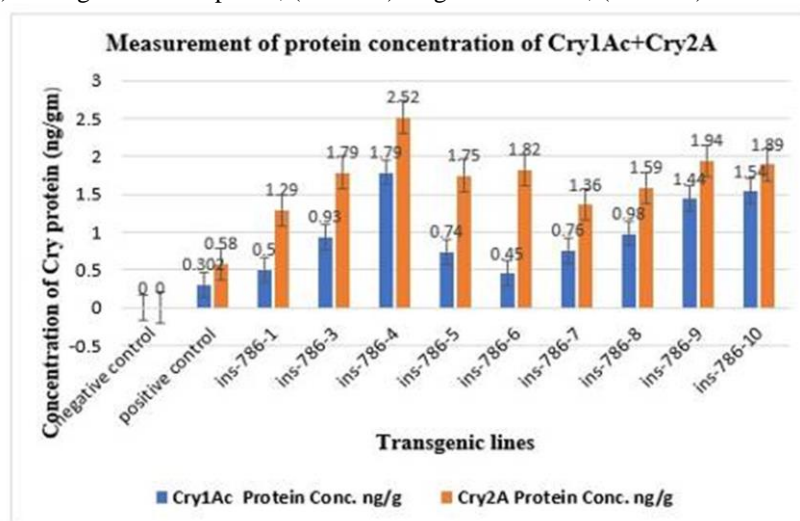

**Figure 3.** Comparison of protein concentration of *Cry1Ac+Cry2A* genes of transgenic cotton plants: (Lane 1) Negative control, (Lane 2) Positive control (pure Cry protein), (Lane 3-11) Protein expression of transgenic cotton plants.

number of inserted genes of *Cry1Ac+Cry2A* in genome of transgenic cotton plants. The transgenic line ins-786-1 (Figure 4-A), ins-786-4 (Figure 4-C), ins-786-5 (Figure 4-D), ins-786-6 (Figure 4-E), ins-786-8 (Figure 4-G) and ins-786-10 (Figure 4-I) had shown one copy of the transgene, while two copies of the transgene were observed in the transgenic line ins-786-3 (Figure 4-B), ins-786-7 (Figure 4-F) and ins-786-9 (Figure 4-H).

#### Location of *Cry1Ac+Cry2A* in Cotton Genome

The transgenic plant line MNH-786 (ins-4) that showed good expression of

*Cry1Ac+Cry2A* and higher yield was subjected to determination of transgene location in its genome by using gene specific probe. All transgenic cotton plants of line MNH-786 (ins-4) gave a signal in the nucleus at chromosome 6 for *Cry1Ac+Cry2A*, while no signal was observed in control plant (Figure 5).

#### Bio-Toxicity Leaf Assay

To determine the efficacy of *Cry1Ac* and *Cry2A* proteins in transgenic cotton plants, leaves were fed to *Heliothis* larvae. Results showed 100% mortality of American Bollworm of the transgenic cotton plants,

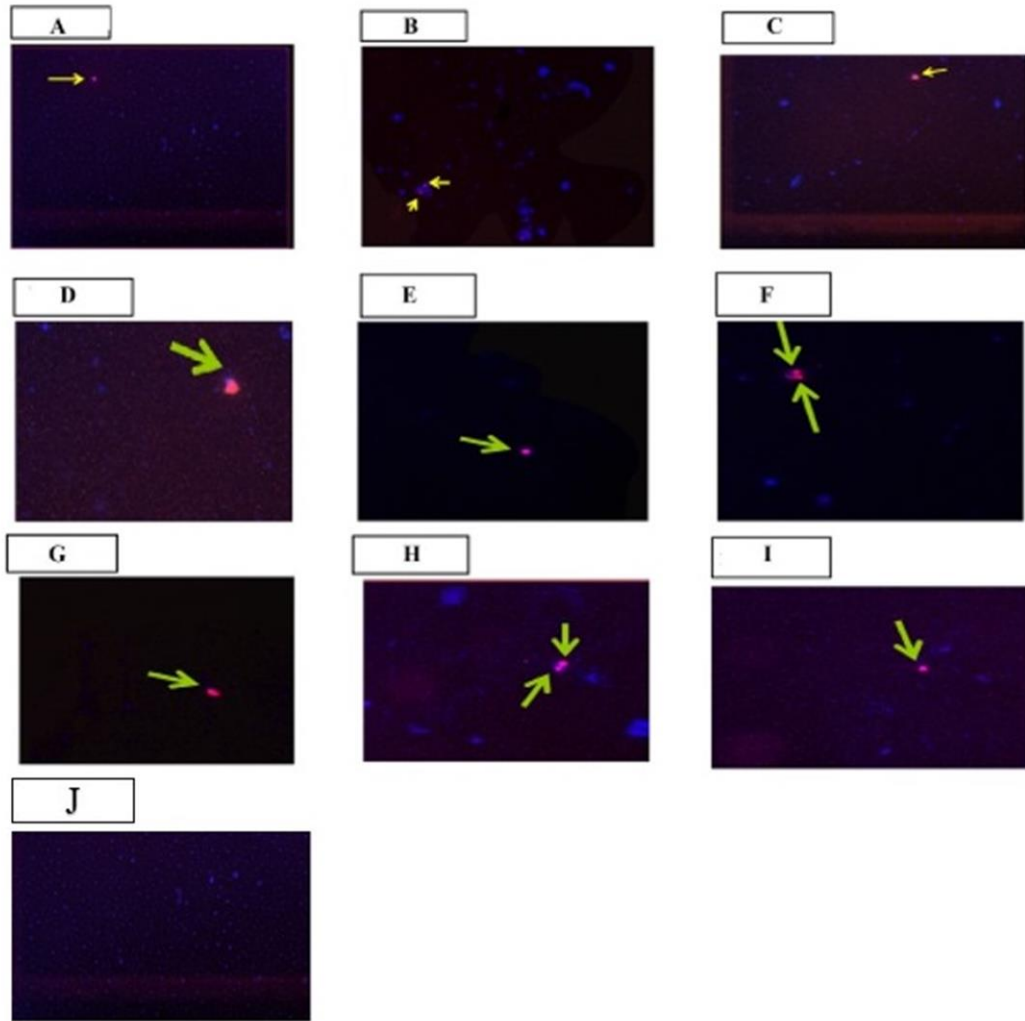
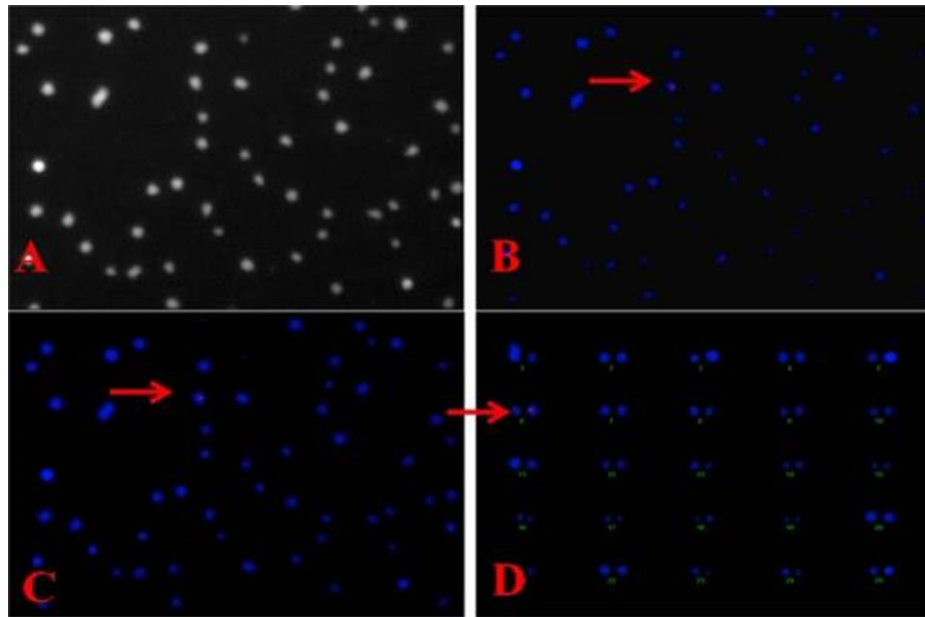

**Figure 4.** FISH analysis of transgenic cotton plants with *Cry1Ac+Cry2A* genes in cotton genomes. Figures from (A) to (I) represent copy numbers of inserted genes into cotton genome. Six transgenic cotton plants (A-I) had one copy of the transgenes, while three transgenic cotton plants showed two such insertions in their genome. Control plant (J) did not produce any signal.

while in the control plant, larvae remained alive and showed an increase in their weight (Figures 6-A and -C). Existing data clearly demonstrates that the transgenic cotton plants have a lethal concentration of Cry toxins, which can kill the insect at initial level as shown in (Figures 6-B and -D). Based on results obtained from insect feeding experiment, comparison of mortality percentage of American Bollworms for T1 and T2 generations of transgenic cotton plants was done (Figure 7).

#### Statistical Analysis of Morphological Characteristics

During Field conditions, morphological data of ten events of transgenic cotton plants of MNH-786 variety was used for the analysis of phenotypic correlation, path coefficient analysis (linear regression weights, which can be used in



**Figure 5.** Location of Transgenes (Cry1Ac+Cry2A) in cotton genome (ins-786-4): (A) Spreading of chromosomes, (B) Probe hybridization, (C) Selection of chromosome for karyotyping, (D) Karyotyping of transgenic cotton plant of MNH-786 (ins-786-4). Note: Arrow determined the Hybridized spot and location of Transgenes after karyotyping.

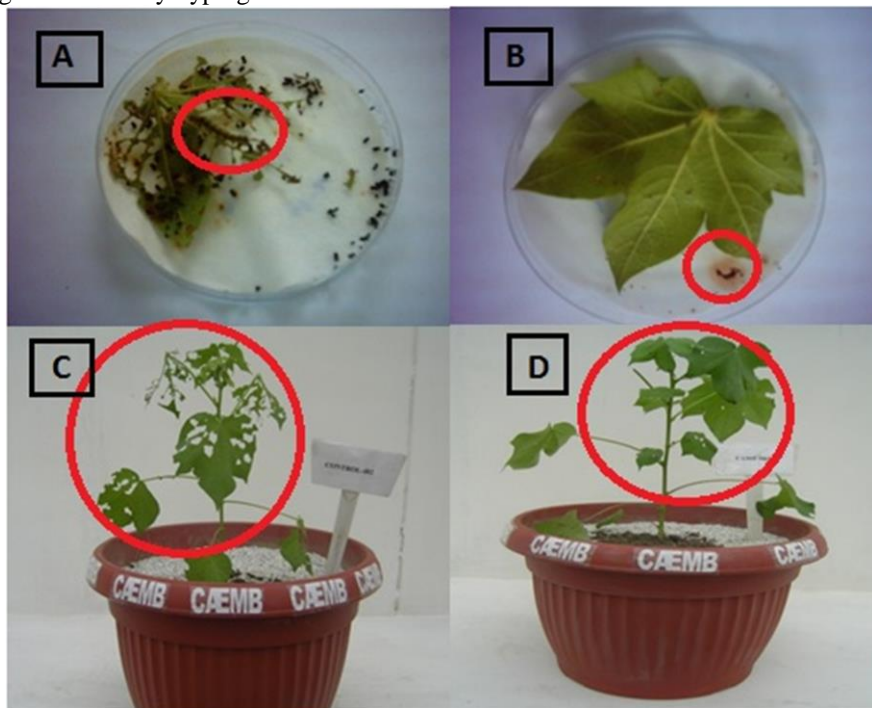

**Figure 6.** Insect feeding bioassay of leaves of transgenic and control cotton plant: (A) in petri plate control, non-transgenic plant, Larvae remained active and alive after damage (T1 generation), (B) Transgenic cotton plant leaf showing killed larvae (T1 generation), (C) In greenhouse condition, larvae damaged control cotton plant (T2 generation), (D) Healthy transgenic cotton plant harboring *Cry1Ac* and *Cry2A* genes.



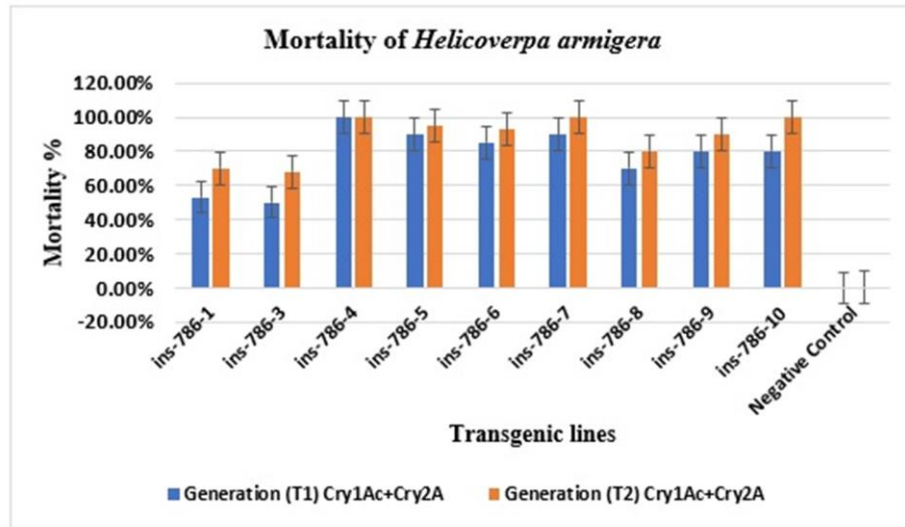

Figure 7. Mortality rate of *Helicoverpa armigera*.

examining the possible causal linkage between statistical variables and covariance. On the basis of statistical analysis, significant correlation was found between Boll Per Plant (BPP) with all of morphological characteristics. Node Per Plant (NPP) depicted positive correlation with BPP, but negative correlation with no. of Flowers Per Plant (FPP). Square Per Plant (SPP) showed positive correlation with BPP,

FPP, and NPP. Mortality rate gave positive correlation with BPP and NPP, but negative correlation with FPP and SPP. Plant height also produced negative correlation with rate of mortality and Boll Weight (BW), but produced positive correlation with all other morphological characteristics.

A straightforward association does not provide an ideal picture of the contribution of numerous traits in total yield. Therefore,

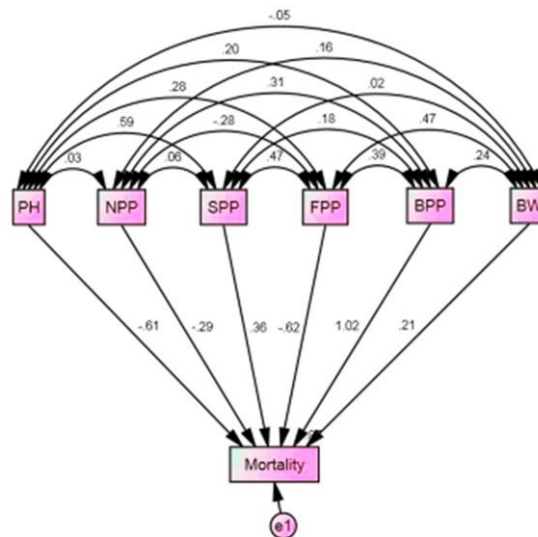

Figure 8. Diagrammatic illustration of direct and indirect effects of various traits on Mortality of transgenic cotton plants at field condition.



Path coefficient analysis was utilized to partition the correlation into direct and indirect effects on mortality. Results of path coefficient regression analysis indicated highly significant correlation between percentage of plant mortality with BPP and BW (Table 1-B, Supplementary data). Figure 9 indicates diagrammatic representation of direct and indirect correlation between mortality and other morphological characteristics. It was persuaded from Table 1-C (Supplementary data) that significant genotypic correlation was found for mortality with BW, BPP, and NPP, but negative correlation with Plant Height (PH), FPP, and SPP.

## DISCUSSION

High yield is the goal of any crop, especially cotton as the main fiber crop in textile industry. However, many constraints such as insects, weeds, and viruses are creating hindrance in production of high yield. Bollworms have been the major issue that still needs to be resolved. Cry proteins have long been used to deal insect pests issues but an optimum and effective combination of these is required, which can minimize the damage in field conditions. Two codon optimized genes of *Bacillus thuringiensis* (Bt), *Cry1Ac+Cry2A* were transformed in the local cotton variety MNH-786 through *Agrobacterium* mediated shoot apex transformation method. Our results correlate with other findings on the improvement of cotton with Bt toxin (Bakhsh et al., 2014; Deng et al., 2014). Another group also reported that the transformation of Cry genes in cotton plants are directly correlated with improvement of crop yield (Ali et al., 2016). Several other studies have reported that genetic modification of cotton plants with Cry genes against bollworms are more efficient than conventional breeding method, but still finding a more effective combination of Cry genes at field level was need of the time (Joshi and Nayak, 2010; Abro et al., 2004).

Gene pyramiding approach was used here by transforming *Cry1Ac+Cry2A* in local cotton variety MNH-786 to achieve multiple traits in a single variety (Rashid et al., 2008). After series of cloning and ligation steps in the sub-vector, the plasmid vector constructs of Cry genes were generated in the T-DNA region of pKHG4 and pCAMBIA 1301, respectively. Similar results of cloning of Bt genes have been reported by Mao et al. (2011). To incorporate the *Bacillus thuringiensis* genes (*Cry1Ac+Cry2A*) into the genome of *Gossypium hirsutum* var. MNH-786, the *Agrobacterium* mediated stable genetic transformation method was used (Rao et al., 2011). A total of 93 plants were obtained out of 9000 cotton embryos utilized for transformation and were considered as putative transgenic cotton plants with an efficiency of 1.03% (Figures 1-C and -H). Similar cotton transformation efficiencies were reported by some researchers (Rao et al., 2011; Bajwa et al., 2015) using the shoot apex method, with 1.1 and 1.24% transformation efficiency.

Based on molecular analysis, 9 transgenic cotton plants produced positive amplification in polymerase chain reaction out of 93 transformed cotton plants in T2 generation (Figure 2). Polymerase chain reaction with an amplification of 585bp fragment confirmed the presence of two Bt genes (*Cry1Ac+Cry2A*, Figure 2). These confirmed transgenic cotton plants were used for further molecular analysis such as determination of gene integration in cotton genome, its location, and protein expression. Enzyme Linked Immuno Sorbent Assay (ELISA) was used for the quantification of *Cry1A* protein in transgenic cotton plants. In this assay, the highest protein expression of Cry protein was obtained in ins-786-4 ins-786-5, ins-786-6 and ins-786-7 and the lowest expression was found in ins-786-1 and ins-786-3 transgenic cotton plants (Figure 3). Bakhsh et al. (2012) also reported similar results against bollworm attack in transgenic cotton plants.

Florescent *In Situ* Hybridization (FISH) was used for confirmation of the integration and location of *Cry* genes on chromosome in all nine events (Figures 4-A and -J). Transgenic cotton events ins-786-3 (Figure 4-B), ins-786-7 (Figure 4-F) and ins-786-9 (Figure 4-H) showed two copies of gene of interest in cotton genome while all other transgenic cotton lines produced one copy number. Level of expression in transgenic cotton plants was dependent upon their copy number because increase in copy number may cause reduction in gene expression. Several factors such as gene positional effects, gene insertion effects, internal cell programming, and its location on chromosome affect gene expression. Few selected transgenic cotton plants (ins-786-4) with high gene expression under field conditions were used for confirmation of gene location on chromosome (Figure 5). Location of transgenes in this plant were traced on chromosome number six (Figure 5-D) from the results of karyotyping of selected transgenic cotton plant (ins-786-4). FISH and karyotyping results were similar to results reported by Q Rao et al., 2013 (Q Rao et al., 2013).

Bollworm biotoxicity assay was done to check the direct effects of the *Cry* proteins against second instar larvae of *Heliothis armigera* (American bollworm). Under lab conditions, newly germinated leaves of transgenic and control cotton plants were fed to 2<sup>nd</sup> instar of larvae. The results of the bioassay indicated that *Cry* protein in transgenic cotton plants produced significant resistance at the time of insect infestation as compared to control cotton plants, which were relentlessly eaten by larvae of American bollworm (Figure 6). Many other studies have reported that pink bollworm, armyworm, and spotted bollworm have shown resistance against *CryIAc* toxin in a consistent way, especially in Bt crop cultivated areas (Rajagopal et al., 2009; Gatehouse, 2008; Kiani et al., 2013).

For statistical analysis of transgenic cotton plants, Pearson correlation analysis was used to determine the association correlation

among different morphological characteristics of transgenic cotton plants according to procedure followed by Farooq et al. (2014). Results of association level of different morphological characteristics are presented in Table 1-A (Supplementary data) and Figure 8. Pearson correlation analysis described that boll per plant produced positive and significant correlation with all of morphological characteristics such as node per plant, square per plant, boll weight, plant height, and mortality. Some other scientists have also reported that boll weight had significant correlation with other morphological characteristics (Ahmad et al., 2008; Karademir et al., 2009; Hamblin et al., 2014).

A straightforward association does not provide ideal picture of the contribution of numerous traits in total yield. Due to this reason, path coefficient analysis was performed to check direct and indirect effects of morphological characteristics on mortality of transgenic cotton plants. Results of path coefficient regression analysis indicated a highly significant correlation between plant mortality with Boll Per Plants (BPP) and Boll Weight (BW). Table 1C (supplementary data) indicated that significant genotypic covariance was found for mortality with BW, BPP, and Node Per Plant (NPP) but negative correlation with Plant Height (PH), Flower Per Plant (FPP) and Square Per Plant (SPP). The upturn in the traits may be fixed based on positive genotypic correlations. A negative correlation suggests that the decline in the trait may be fixed in the next generations. The present results reflected the findings reported by Hamblin et al. (2014) and Ahsan et al. (2015). From either molecular or field results, we can infer that genetic modifications of cotton develop a significant improvement in morphological characteristics that produces direct effect on cotton seed yield. The results also suggest that genetic expression of *Bt* and *herbicide resistant* genes in cotton could be a useful method of cotton biotechnology for



improvement of resistance against insect and weeds, the natural competitors.

## CONCLUSIONS

The results of the present study support the hypothesis that genetic expression of Cry genes in transgenic cotton plants leads to improved resistance against *Helicoverpa armigera*. Here, we report significant control of insects in transgenic cotton plants through successful integration and expression of *CryIAC+Cry2A* genes. The results indicate that transgenic cotton plants that express *CryIAC+Cry2A* genes in combination are more effective as compared to control cotton plants, which ultimately leads to reduced insect damage that is directly proportional to an increase in yield.

## ACKNOWLEDGEMENTS

We are highly thankful to the Director, Central Cotton Research Institute (CCRI), Multan, Pakistan for providing seeds of cotton variety MNH-786. We are also thankful to Pakistan Agriculture Research Board (PARB), Lahore, Pakistan for providing research funding for this project.

## REFERENCES

1. Abro, G., Syed, T., Tunio, G. and Khuhro, M. 2004. Performance of Transgenic Bt Cotton against Insect Pest Infestation. *Biotechnology*, **3**: 75-81.
2. Ahmad, M.Q., Khan, S. H. and Azhar, F. M. 2012. Decreasing Level of Genetic Diversity in Germplasm and Cultivars of Upland Cotton (*Gossypium hirsutum*) in Pakistan. *J. Agr. Soc. Sci.*, **8**. Pages??
3. Ahmad, W., Khan, N., Khalil, M., Parveen, A., Saeed, M. and Shah, S. 2008. Genetic Variability and Correlation Analysis in Upland Cotton. *Sarhad Journal of Agriculture (Pakistan)*, **24(4)**: 573-580.
4. Ahsan, M. Z., Majidano, M. S., B.hutto, H., Soomro, A. W., Panhwar, F. H., Channa, A. R. and Sial, K. B. 2015. Genetic Variability, Coefficient of Variance, Heritability and Genetic Advance of Some *Gossypium hirsutum* L. Accessions. *J. Agr. Sci.*, **7**: 147.
5. Ali, A., Ahmed, S., Nasir, I. A., Rao, A. Q., Ahmad, S. and Husnain, T. 2016. Evaluation of Two Cotton Varieties CRSP1 and CRSP2 for Genetic Transformation Efficiency, Expression of Transgenes *CryIAC+Cry2A*, *GT* Gene and Insect Mortality. *Biotechnol. Rep.*, **9**: 66-73.
6. Awan, M., Abass, M., Muzaffar, A., Ali, A., Tabassum, B., Rao, A., Ahmad Nasir, I. and Husnain, T. 2015. Transformation of *Insect* and *Herbicide Resistance* Genes in Cotton (*Gossypium hirsutum* L.). *J. Agr. Sci. Tech.*, **17**: 287-298.
7. Bajwa, K. S., Shahid, A. A., Rao, A. Q., Bashir, A., Aftab, A. and Husnain, T. 2015. Stable Transformation and Expression of GhEXPA8 Fiber Expansin Gene to Improve Fiber Length and Micronaire Value in Cotton. *Front. Plant Sci.*, **6**. 1-13.
8. Bajwa, K. S., Shahid, A. A., Rao, A. Q., Kiani, M. S., Ashraf, M. A., Dahab, A. A., Bakhsh, A., Latif, A., Khan, M. A. U. and Puspito, A. N. 2013. Expression of *Calotropis Procera* Expansin Gene *CpEXPA3* Enhances Cotton Fibre Strength. *Aust. J. Crop Sci.*, **7**: 206.
9. Bakhsh, A., Anayol, E. and Ozcan, S. F. 2014. Comparison of Transformation Efficiency of Five Agrobacterium Tumefaciens Strains in Nicotiana Tabacum L. *Emirates Journal of Food and Agriculture*, **26**: 259.
10. Bakhsh, A., Rao, A. Q., Shahid, A. A. and Husnain, T. 2012. Spatio Temporal Expression Pattern of an *Insecticidal* Gene (*Cry2A*) in Transgenic Cotton Lines. *Notulae Scientia Biologicae*, **4**: 115.
11. Bakhsh, A., Rao, A. Q., Shahid, A. A., Husnain, T. and Riazuddin, S. 2009. CaMV 35S Is a Developmental Promoter Being Temporal and Spatial in Expression Pattern of Insecticidal Genes (*Cry1Ac* & *Cry2A*) in Cotton. *Res. J. Cell Mol. Biol.*, **3**: 56-62.
12. Christou, P., Buiatti, M. and Pastore, G. 2013. The Application of GMOs in Agriculture and in Food Production for a Better Nutrition: Two Different Scientific

- Points of View. *Genes Nutr.*, **8(3)**: 255–270.
13. De Oliweira, R. S., Oliveira-Neto, O. B., Moura, H. F., De Macedo, L. L., Arraes, F. B., Lucena, W. A., Lourenco-Tessutti, I. T., De Deus Barbosa, A. A., Da Silva, M. C. and Grossi-De-Sa, M. F. 2016. Transgenic Cotton Plants Expressing *CryIIa12* Toxin Confer Resistance to Fall Armyworm (*Spodoptera frugiperda*) and Cotton Boll Weevil (*Anthonomus grandis*). *Front. Plant Sci.*, **7**: 1-11.
  14. Deng, L., Weng, L. and Xiao, G. 2014. Optimization of *Epsps* Gene and Development of Double Herbicide Tolerant Transgenic PGMS Rice. *J. Agr. Sci. Tech.*, **16**: 217-228.
  15. DOS SANTOS, V. B., SILVA, L. B., CARNEIRO, E., SILVA, A. F., LOPES, G. N., Pavan, B. E. and Rodrigues, T. F. 2017. Comparative Study of *Helicoverpa armigera* (Hubner) (Lepidoptera: Noctuidae) Preference for Bt and Non-Bt Soybean Cultivars. *Am. J. Plant Sci.*, **8**: 2483.
  16. Economic Survey of Pakistan, 2014. [http://www.finance.gov.pk/survey\\_1415.html](http://www.finance.gov.pk/survey_1415.html)
  17. Ehsan, F., Ali, A., Nadeem, M. A., Tahir, M. and Majeed, A. 2008. Comparative Yield Performance of New Cultivars of Cotton (*Gossypium hirsutum* L.). *Pak. J. Life Soc. Sci.*, **6**: 1-3.
  18. Farooq, J., Anwar, M., Riaz, M., Farooq, A., Mahmood, A., Shahid, M., Rafiq, M. and Ilahi, F. 2014. Correlation and Path Coefficient Analysis of Earliness, Fiber Quality and Yield Contributing Traits in Cotton (*Gossypium hirsutum* L.). *JAPS: J. Anim. Plant Sci.*, **24**: 781-790
  19. Gatehouse, J. A. 2008. Biotechnological Prospects for Engineering Insect-Resistant Plants. *Plant Physiol.*, **146**: 881-887.
  20. Hamblin, J., Stefanova, K. and Angessa, T. T. 2014. Variation in Chlorophyll Content per Unit Leaf Area in Spring Wheat and Implications for Selection in Segregating Material. *PloS One*, **9**: e92529.
  21. Ilias, F., Gaouar, N., Medjdoub, K. and Awad, M. K. 2013. Insecticidal Activity of *Bacillus thuringiensis* on Larvae and Adults of *Bactrocera oleae* Gmelin (Diptera: Tephritidae). *J. Environ. Prot.* **4(5)**: 480-485.
  22. Jisha, V. N., Smitha, R. B. and Benjamin, S. 2013. An Overview on the Crystal Toxins from *Bacillus thuringiensis*. *Adv. Microbiol.*, **3**: 462.
  23. Johar Campus, H. 2005. In-Ovule Embryo Culture: A Novel Method of Cotton Transformation. *Pak. J. Biol. Sci.*, **8**: 297-301.
  24. Joshi, R. K. and Nayak, S. 2010. Gene Pyramiding-A Broad Spectrum Technique for Developing Durable Stress Resistance in Crops. *Biotechnol. Mol. Biol. Rev.*, **5**: 51-60.
  25. Karademir, C., Karademir, E., Ekinici, R. and Gencer, O. 2009. Correlations and Path Coefficient Analysis Between Leaf Chlorophyll Content Yield and Yield Components in Cotton (*G. hirsutum* L.) under Drought Stress Conditions. *Notulae Botanicae Horti Agrobotanici Cluj-Napoca*, **37**: 241.
  26. Keshamma, E., Rohini, S., Rao, K., Madhusudhan, B. and Kumar, M. U. 2008. Tissue Culture-Independent in Planta Transformation Strategy: An *Agrobacterium tumefaciens*-Mediated Gene Transfer Method to Overcome Recalcitrance in Cotton (*Gossypium hirsutum* L.). *J. Cotton Sci.*, **12(3)**: 264-272.
  27. Khan, M. A. U., Shahid, A. A., Rao, A. Q., Shahid, N., Latif, A., Ud Din, S. and Husnain, T. 2015. Defense Strategies of Cotton against Whitefly Transmitted CLCuV and Begomoviruses. *Advancements in Life Sciences*, **2**, 58-66.
  28. Kiani, S., Mohamed, B. B., Shehzad, K., Jamal, A., Shahid, M. N., Shahid, A. A. and Husnain, T. 2013. Chloroplast-Targeted Expression of Recombinant Crystal-Protein Gene in Cotton: An Unconventional Combat with Resistant Pests. *J. Biotechnol.*, **166**: 88-96.
  29. Konecka E., Baranek, J., Bielinska, I., Tadeja, A. and Kaznowski, A. 2014. Persistence of the Spores of *B. thuringiensis* subsp. Kurstaki from Foray Bioinsecticide in Gleysol Soil and on Leaves. *Sci. Total Environ.*, **472**: 296-301.
  30. Mao, Y. B., Tao, X. Y., Xue, X. Y., Wang, L. J., & Chen, X. Y. 2011. Cotton Plants Expressing CYP6AE14 Double-stranded RNA Show Enhanced Resistance to Bollworms. *Transgenic research*, **20(3)**: 665-673



31. Puspito, A. N., Rao, A. Q., Hafeez, M. N., Iqbal, M. S., Bajwa, K. S., ALI, Q., Rashid, B., Abbas, M. A., Latif, A. and Shahid, A. A. 2015. Transformation and Evaluation of *CryIAc+Cry2A* and *GT* Genes in *Gossypium hirsutum* L. *Front. Plant Sci.*, **6**: 943.
32. Rao, A. Q., Bajwa, K. S., Puspito, A. N., Khan, M., Abbas, M. A., Bakhsh, A., SHAHID, A., Nasir, I. A. and Husnain, T. 2013. Variation in Expression of *Phytochrome B* Gene in Cotton (*Gossypium hirsutum* L.). *J. Agr. Sci. Tech.*, **15**: 1033-1042.
33. Rajagopla, R., Arora, N., Sivakumar, S., Rao, N. G., Nimbalkar, S. A. and Bhatnagar, R. K. 2009. Resistance of *Helicoverpa armigera* to *CryIAc* Toxin from *Bacillus thuringiensis* Is Due to Improper Processing of the Protoxin. *Biochem. J.*, **419**: 309-316.
34. Rao, A. Q., Bakhsh, A., Kiani, S., Shahzad, K., Shahid, A. A., Husnain, T. and Riazuddin, S. 2009. The Myth of Plant Transformation. *Biotechnol. Adv.*, **27**: 753-763.
35. Rao, A. Q., Irfan, M., Saleem, Z., Nasir, I. A., Riazuddin, S. and Husnain, T. 2011. Overexpression of the *Phytochrome B* Gene from *Arabidopsis thaliana* Increases Plant Growth and Yield of Cotton (*Gossypium hirsutum*). *J. Zhejiang Univ. Sci. B*, **12**: 326-334.
36. Rashid, B., Saleem, Z., Husnain, T. and Riazuddin, S. 2008. Transformation and Inheritance of *Bt* Genes in *Gossypium hirsutum*. *J. Plant Biol.*, **51**: 248-254.
37. Razmjou, J., Naseri, B. and Hemati, S. A. 2014. Comparative Performance of the Cotton Bollworm, *Helicoverpa armigera* (Hübner) (Lepidoptera: Noctuidae) on Various Host Plants. *J. Pest Sci.*, **87**: 29-37.
38. Sambrook, J. R. and Russell, P. D. W. 2006. *The Condensed Protocols from Molecular Cloning: A Laboratory Manual*. Cold Spring Harbor Laboratory Press, Cold Spring Harbor, NY.
39. Sharaby, A. and Al Dhafar, Z. M. 2019. Some Natural Plant Extracts Having Biocide Activities against the American Bollworm *Helicoverpa armigera* (Lepidoptera: Noctuidae). *Advances in Entomology*, **7**: 10-20.
40. Wendel, J. F. and Cronn, R. C. 2003. Polyploidy and the Evolutionary History of Cotton. *Adv. Agron.*, **78**: 139-186.

## ترکیب *Cry2A* و *CryIAc* برای ایجاد مقاومت علیه *Helicoverpa armigera*

### در پنبه

ک. س. باجوا، م. اعظم علی، ا. ک. راوو، ا. ا. شاهید، و ت. حسنین

### چکیده

دستکاری ژنتیکی برای ایجاد ویژگی های مطلوب در گیاهان پر فروش منجمله پنبه همچنان هدف اصلی بیوتکنولوژی (زیست فناوری) گیاهان است. برای تولید گیاهان تراریخته مقاوم علیه کرم غوزه (bollworm)، نطفه های تازه رقم MNH-786 پنبه با اگروباکتریوم تومفاسینس با سویه LBA4404 با پلاسمید pKHG4 ناقل ژن های *CryIAc+Cry2A* تحت کنترل *CaMV35S* انداز (promoter) تراریخته شد. برای ارزیابی یکپارچگی و بیان این ژن ها، به ترتیب از PCR، دورگه سازی در جای فلورسنتی (FISH)، و ELISA استفاده شد. در میان ۷۰۰ بوته

پنبه فرضا (putative) تراریخته، ۱۰ بوته (۱/۰۳٪ راندمان تراریختی) حضور ژن های *CryIAC+Cry2A* را با روش تحلیل PCR نشان دادند. در آزمون درون شیشه، زیست آزمون تغذیه حشرات برای برآورد (mortality percentage) درصد میرندگی *Helicoverpa armigera* به کار رفت. نرخ میرندگی حشرات و ویژگی های مورفولوژیکی پنبه Bt با همبستگی فنوتیپی، رگسیون ضریب مسیر، و کوواریانس تحلیل و تجزیه شد تا بتوان فواید فناوری تراریختی را به صورت عددی برآورد کرد. تحلیل آماری به همبستگی مثبت معناداری بین میرندگی حشرات و عملکرد پنبه دانه اشاره داشت. داده های مرگ و میر *Helicoverpa armigera* یک رابطه مستقیم و متناسب با عملکرد پنبه دانه به دست داد. از نتایج این آزمایش چنین برمیآید که با تغییرات ژنتیکی می توان سازو کار دفاعی پنبه را بر علیه حشرات و رقبای طبیعی بهبود بخشید.