

Comparison of Two Methods of Solvent Extraction of Phenolic Compounds from Pomegranate (*Punica granatum* L.) Peels

P. Rahnemoon¹, M. Sarabi Jamab^{1*}, M. Javanmard Dakheli², A. Bostan³, and O. Safari⁴

ABSTRACT

The present study aimed to evaluate effectiveness of Superheated Solvent Extraction (SSE) compared with instant Controlled Pressure Drop (DIC) assisted Solvent Extraction (DIC-SE) on total phenolic, flavonoids, and anthocyanins compounds from pomegranate peels. The effects of temperature, extraction time, and water:ethanol ratio for SSE method, and temperature and heating time for DIC-SE were studied. The highest phenolic compounds, flavonoids, and extraction yields by SSE was achieved at 160°C, ethanol: water 50:50 and 20 minutes, subsequently in the DIC-SE, the most effectiveness was approached at 150°C for 5 seconds ($P < 0.05$). The SSE improved the total phenolic compounds ($563.16 \pm 1.04 \text{ mg g}^{-1}$), anthocyanins ($285.11 \pm 1.02 \text{ mg } 100 \text{ g}^{-1}$), extraction yield (68.7%) and shortened the extraction times compared to DIC-SE, but flavonoid content was more in DIC-SE extract ($439.07 \pm 0.05 \text{ mg g}^{-1}$). Based on HPLC analyses, gallic acid was not detected in any of the obtained extracts, but the amount of ellagic acid and punicalagin A and B in DIC-SE extract was higher than SSE. The current study clearly shows that the SSE is an effective extraction method to obtain phenolic compounds and the DIC is an advantageous pretreatment for extraction of flavonoids from pomegranate peels.

Keywords: Anthocyanins, Bioactive compounds, DIC, Flavonoids, SSE.

INTRODUCTION

Some plant wastes are a major source of bioactive compounds such as phenolic and flavonoid compounds. Pomegranate (*Punica granatum*) peels, regarded as waste, constitute 40% of all pomegranates fruit which has high amount of phenolic compounds (Cam *et al.*, 2014). Phenolic compounds of pomegranate have high biological activities such as antioxidant, antimicrobial, antimutagenic and anticarcinogenic activity (Gullon *et al.*, 2016; Mansour *et al.*, 2013; Sadeghi *et al.*, 2009;

Yasoubi *et al.*, 2007). Gallic acid, ellagic acid and punicalagin are important pomegranate peels polyphenols (Qu *et al.*, 2012; Akhavan *et al.*, 2015). Extraction method of polyphenols is one of the important factors in availability of these compounds. In most studies, the conventional solvent extraction method is used to obtain the pomegranate peel extracts. Conventional methods are often a slow process and consumption of solvent is high.

Superheated Solvent Extraction (SSE) is an efficient method for extraction of phenolic compounds compared with conventional solvent extraction method (Shang *et al.*, 2014).

¹ Department of Food Biotechnology, Research Institute of Food Science and Technology (RIFST), Mashhad, Islamic Republic of Iran.

² Department of Food Technology, Iranian Research Organization for Science and Technology (IROST), Tehran, Islamic Republic of Iran.

³ Department of Nanotechnology, Research Institute of Food Science and Technology (RIFST), Mashhad, Islamic Republic of Iran.

⁴ Department of Fishery, Faculty of Natural Resources and Environment, Ferdowsi University of Mashhad, Mashhad, Islamic Republic of Iran.

*Corresponding author; e-mail: m.sarabi@rifst.ac.ir



This technique is a green extract method due to it is decreased solvent use. In addition, SSE requires less time (Wijngaard *et al.*, 2012). During SSE, due to applying pressure, the solvent maintains liquid at temperatures above its boiling point. Extraction at high temperature can increase extraction efficiency (Wijngaard *et al.*, 2012). The some application of SSE is, up to now, to extract phenolic compounds from grape skins (Luque-Rodriguez *et al.*, 2007), olive leaves (Japon-Lujan *et al.*, 2006), pomegranate peel (Cam and Hisil, 2010), pomegranate seed (He *et al.*, 2012) and black bamboo leaves (Shang *et al.*, 2014). In all of these studies, the SSE process showed significantly improved recovery of polyphenols compared to conventional methods. However, there is no study about the comparison between SSE and DIC assisted solvent extraction of phenolic compounds from plant source.

Instant Controlled Pressure Drop (DIC) could be as a pretreatment for extraction of phenolic compounds from plant material (Allaf *et al.*, 2013b). DIC is a thermo-mechanical process that raw materials are exposed to saturated steam pressure (up to 10^6 Pa) at high temperature (up to 170°C) for a short period of time (Allaf *et al.*, 2013b). Then, pressure drops towards a vacuum state abruptly. Due to abrupt drop in pressure, volatile compounds automatically vaporize, which results in an expansion of the sample. DIC texturing enhances mass transfer and makes solvent extraction easier. Without texturing, solvent diffusion into a compact solid matrix is often a slow process and availability of plant bioactive compounds is low (Ben-Amor and Allaf, 2009).

In several studies, SSE has been used for extraction of phenolic compounds from plants. But, in this study, we aimed to compare SSE and DIC-SE methods with regard to their effect on the amount of Total Phenolic Compounds (TPCs), Total Flavonoids (TFs), Total Anthocyanin Compounds (TACs) and extraction yields of Pomegranate Peel Extracts (PPEs).

MATERIALS AND METHODS

Plant Material

Pomegranate fruit of “Pishras” cultivar was obtained from the local market (September 2014). Peels were manually separated and dried away from sunlight at room temperature for 8 days. The moisture content of dried peels was $9.6\pm 0.3\%$ (dry base). Dried peels were ground (Moulinex, France) and passed through standard sieve (35 meshes). The obtained powder was used for extraction by SSE and Conventional Solvent Extraction (CSE).

Chemicals

Folin–Ciocalteu reagent, gallic acid, rutin, aluminium chloride, sodium hydroxide, sodium nitrite, sodium carbonate, acetic acid, sodium acetate, hydrochloric acid supplied by Merck Chemical Co (Darmstadt, Germany). Ethanol 96% was purchased from Noor Zakariyaye Razi factory (Iran).

Extraction

Superheated Solvent Extraction

SSE was carried out in laboratory-built apparatus (Figure 1). In each run, 5 g of pomegranate peel powder was loaded in a filter paper to avoid blockage of system lines. The filter paper was then loaded in to stainless steel cell. After locating the cell in a fan-equipped temperature controlled oven (Teb Azma Co, Iran), the cell was heated to the working temperature (100, 130, 160 and 190°C). Then, the cell was filled with the specified ethanol and water concentration. The system was pressurized to 1,500 psi. When the pressure and temperature reached the pre-determined value, extracts were collected in glass vials. Flow rate of the solvent was 1 mL min^{-1} . The extracts were centrifuged at 3,500 rpm (universal centrifuge, Poya Electronic,

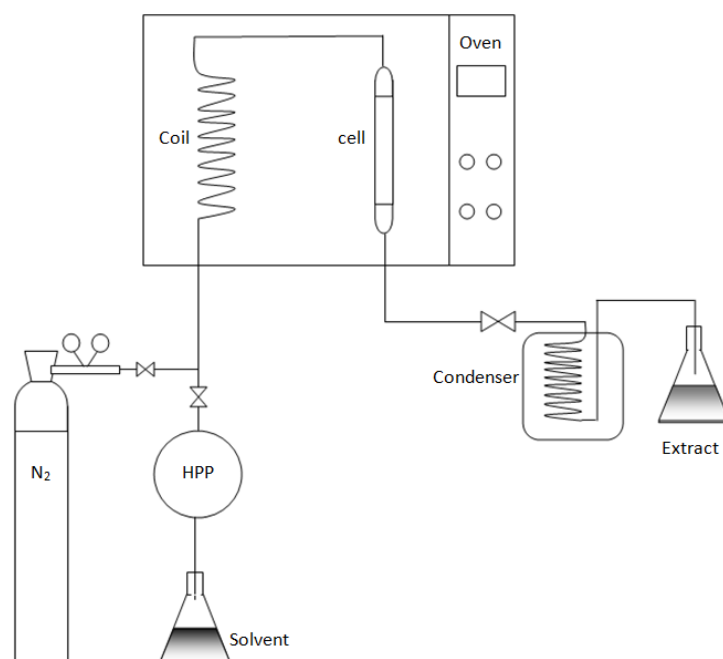

Figure 1. Schematic diagram of superheated solvent extraction apparatus. N₂: Nitrogen capsule, HPP: High Pressure Pump.

Iran) for 10 minutes and the supernatant was collected. The liquid extracts after filtering by Watman no. 1, were dried by vacuum oven (Gallenkamp vacuum oven, United Kingdom) at 40°C.

DIC Pretreatment Extraction

DIC lab-scale equipment was setup in laboratory (Figure 2). Dried pieces of pomegranate peel were firstly placed in the DIC treatment chamber. Then, the first vacuum stage was established in order to reduce their resistance and facilitate the entering of the saturated steam into the reactor. After closing the pneumatic valve, high-pressure steam (0.3-0.5 MPa) was injected into the reactor and maintained during the treatment. The thermal treatment was followed by an abrupt pressure drop towards a vacuum (-0.085 MPa). The resulting auto vaporization induced an instant cooling of the material. After the treatment, samples were recovered and dried at room temperature (in DIC process, dried peels usually absorb some

moisture because of injection of high pressure steam) and then ground to powder (35 mesh) using a grinder (Molinox, France). Five g of the obtained powder was dissolved in 50 mL of ethanol:water (60:40). Extraction was carried out at 25°C for 24 hours (Rahneemoun *et al.*, 2017). After filtering, the extracts were centrifuged at 3500 rpm (universal centrifuge, Poya Electronic, Iran) for 10 minutes and the supernatant was collected. The liquid extracts after filtering were dried by vacuum oven (Gallenkamp vacuum oven, United Kingdom) at 40°C.

Determination of Total Phenolic Compounds (TPCs)

The concentration of TPCs was measured using Folin-Ciocalteu assay (Singleton *et al.*, 1999). Briefly, 3 mL of distilled water, 0.3 mL of extract, and 2 mL of aqueous Folin-Ciocalteu solution (diluted 10 mL of Folin-Ciocalteu reagent in 100 mL water) were mixed in a 10 mL volumetric flask. After 3

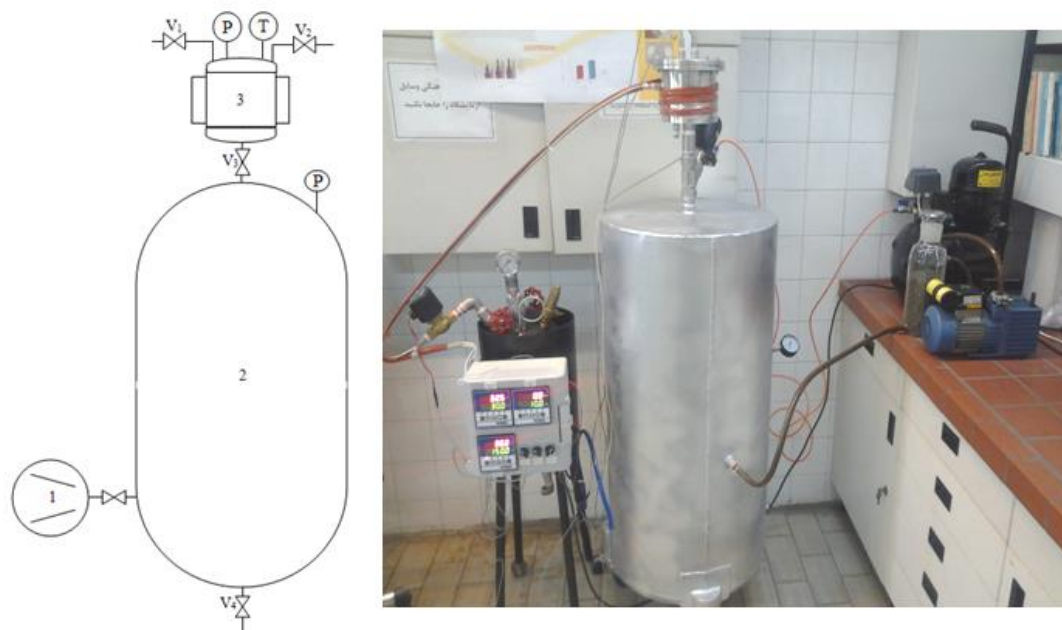

Figure 2. Instant Controlled Pressure Drop (DIC) apparatus. (1) Vacuum Pump; (2) Vacuum tank; (3) DIC treatment chamber; (V1) Steam inlet valve; (V2 and V4) Discharge valve, (V3) Pneumatic vacuum valve.

minutes, 2 mL of 7.5% (w/w) NaHCO_3 solution was added to the solution. The final volume of solution was adjusted to 10 mL by addition of distilled water and was placed in the dark at room temperature for 1 hour. Absorbance was measured at 760 nm using a UV-Vis spectrophotometer (Cecil CE 2040). The calibration curve for UV-Vis spectrophotometer was acquired using standard solution of gallic acid with known concentration, varied in the range of 0.1 to 1.00 mg mL^{-1} . A linear equation with R^2 of 0.995 was established and TPCs was expressed as milligrams of Gallic Acid Equivalents per gram of dried extract ($\text{mg GAE g}^{-1} \text{de}$).

Determination of Total Flavonoids (TFs)

The concentration of TFs was measured using the colorimetric method described by Blasa *et al.* (2005). Briefly, 1 mL of extract was mixed with 4 mL distilled water and 0.3 mL of 5% (w/w) sodium nitrite solution. After 5 minutes, 0.3 mL of 10% (w/w) aluminum

chloride was added to the solution followed by addition of 2 mL of 1M sodium hydroxide after 6 minutes. The final volume of solution was increased to 10 mL, using distilled water. The UV-Vis spectrophotometer (Cecil CE 2040) was used at wavelength of 510 nm to measure the absorbance of TFs. The calibration curve for this measurement was established from standard solution of rutin with predefined concentration, varied in the range of 0.1 to 1 mg mL^{-1} . A linear equation with R^2 of 0.985 was established and TFs was expressed as milligrams of Rutin equivalents per gram of dried extract ($\text{mg R g}^{-1} \text{de}$).

Determination of Total Anthocyanin Compounds (TACs)

TACs was determined by using pH differential method at pH 4.5 and pH 1.0 (Cheng and Breen, 1991). Briefly, 0.4 mL of extract solution was mixed with 3.6 mL of pH 1.0 buffer (Hydrochloric acid- Potassium chloride buffer, 50 mL of 0.2 M potassium chloride was added to 134 mL of 0.2M hydrochloric acid and made up to 200 mL with

distilled water), and pH 4.5 buffer (sodium acetate-Acetic acid buffer, 126 mL of 0.1M acetic acid was added to 74 mL of 0.1M sodium acetate) separately and was read at both 520 and 700 nm. Where $A = (A_{520} - A_{700})_{pH=1.0} - (A_{520} - A_{700})_{pH=4.5}$. The absorbance of a blank cell filled with distilled water was measured within 20–50 min of preparation. Anthocyanin concentration was measured and expressed as cyanidin-3-glucoside equivalents (molar extinction coefficient of 29.6 and molecular weight of 449.2) equivalents per 100 g of dried extract.

HPLC Analysis of Phenolic Compounds of Extracts

HPLC analyses were performed using a Sykam (Eresing, Germany) HPLC system equipped with a S2100 pump, a S1122 secondary pump, a S3240 UV-Vis detector and a Genesis RP C18 analytical column (250×4.6 mm, dp 4 μm). Ellagic acid, gallic acid, punicalagin A and B were quantified using calibration curve of the respective reference compounds. For this purpose, stock solutions (1,000 mg L⁻¹) were diluted to concentrations of 0.5-500 mg L⁻¹ and were injected to the system. Methanol: ethyl acetate: water (25: 5: 70 v/v) with a flow rate of 1 mL min⁻¹ was selected as mobile phase for separation of these compounds (Sawant and Chavan, 2013). Analyses were conducted at constant temperature of 30°C. Sample injection volume was 20 μL. Detector wavelengths of 270, 245, and 258 nm for gallic acid, ellagic acid and punicalagin were selected, respectively (Qu *et al.*, 2012).

Experimental Design

After confirming the homogeneity of variance and normality of the data using Leaven and Kolmogorov-Smirnov tests, respectively; two-way ANOVA was used to compare the treatments. A series of SSE experiments at different temperatures (T: 100, 130, 160 and 190°C), ethanol: water ratio (100:0, 50:50 and

0:100) and extraction time (t: 10, 20, and 30 minutes) was performed. DIC pretreatment was applied at different temperatures (110, 130 and 150°C) and time (5, 10, 15, 20 and 25 seconds). All experiments were performed in triplicate. Analysis Of Variance (ANOVA) was performed by SPSS for Windows, version 21.0.0. Duncan test was applied to compare significant differences among the treatments (P < 0.05).

RESULTS AND DISCUSSION

The most effective factors on the TPC and TF extractions by SSE method is temperature followed by alcohol concentration in the solvent (Shang *et al.*, 2014). Pressure, particle size, and static time could also affect extraction yield and amount of phenolic compounds in SSE (Ju and Howard, 2003). Pressure of the system was set at 1,500 psi, which is the standard operating pressure in SSE extractions (Cam and Hisil, 2010). Temperature, ethanol concentration, and extraction time were the independent factors. Due to food application, ethanol and water were used as the extraction solvent (Shang *et al.*, 2014). Also, some preliminary experiments carried out during the first stage of our work allowed us to identify the more important parameters of the DIC process used for the pretreatment of pomegranate peel (data not show). The main operative parameters seemed to be the Temperature (T) and the thermal treatment time (t). Number of DIC cycle had no significant effect on extraction yield and phenolic contents as Mkaouar *et al.* (2015) has reported before. The initial water content has ignorable effect on extraction of TPCs (Ben- Amor and Allaf, 2009). Therefore, it was considered as a fixed factor. Thermal treatment was achieved using saturated steam with pressure varying from 0.3 up to 0.5 MPa.

Superheated Solvent Extraction

The effect of temperature, type of solvent, and extraction time on extraction yield, TPCs, TFs and anthocyanins of pomegranate peel by



SSE method is shown in Figures 3, 4, 5, and 6, respectively. As Figure 3 shows, extraction yield was increased with the rise in extraction temperature from 100 to 160°C and decreased at 190°C when different types of solvents were used. Maximum amount of extraction yield was achieved by ethanol: water 50:50, 100% water and 100% ethanol, respectively (Figure 3). The highest extraction yield was obtained in 20 minutes and didn't need the excess time

for extraction (Figure 3).

According to Figures 4 and 5, at 160°C, 20 minutes and ethanol: water 50:50, the highest amount of TPCs (563.489 mg GAE g⁻¹ de) and TFs (278.09 mg R g⁻¹ de) was achieved ($P < 0.05$). Similar to our results, Sharifi *et al.* (2013) reported that the optimized subcritical water extraction condition for polyphenols from Barberry fruits was 157.5°C and 29.6 minutes. As it is shown in Figures 4 and 5,

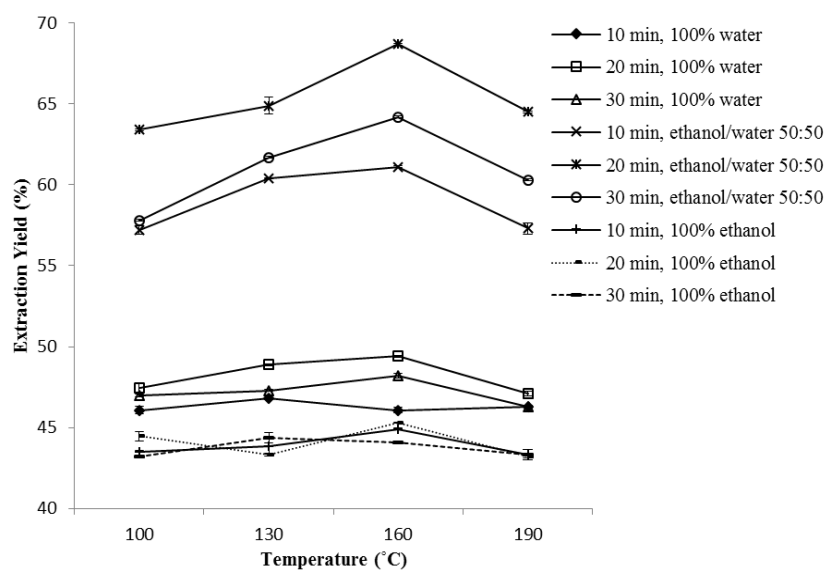

Figure 3. The effect of extraction temperature, time and ethanol/water ratio of SSE method on extraction yield of PPEs

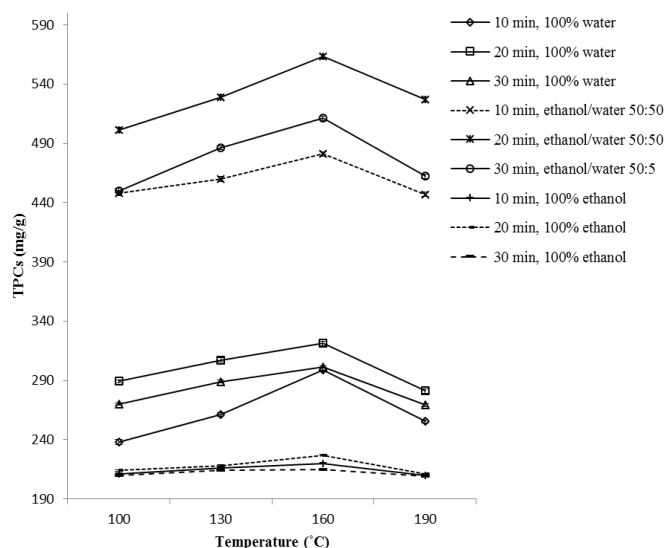

Figure 4. The effect of extraction temperature, time and ethanol/water ratio of SSE method on TPCs of PPEs.

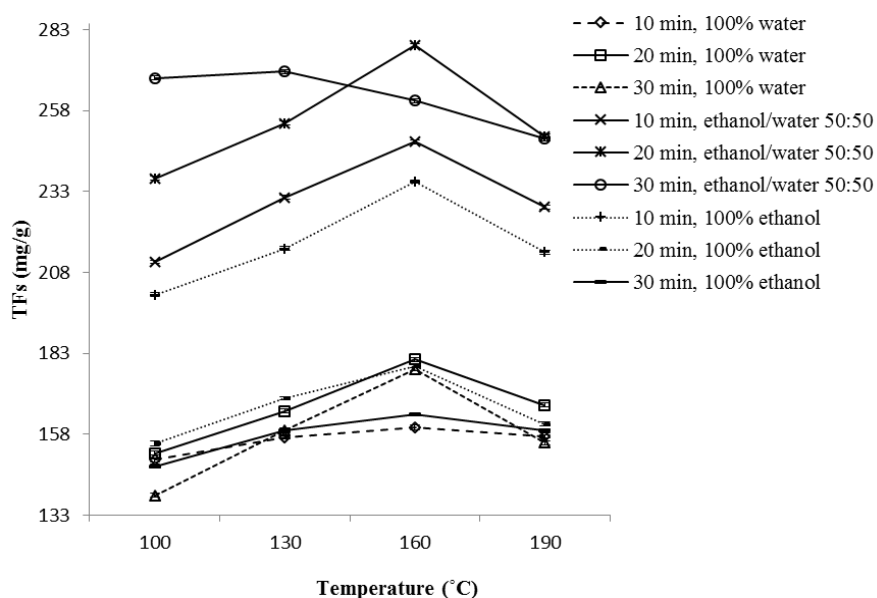

Figure 5. The effect of extraction temperature, time and ethanol/water ratio of SSE method on TFs of PPEs.

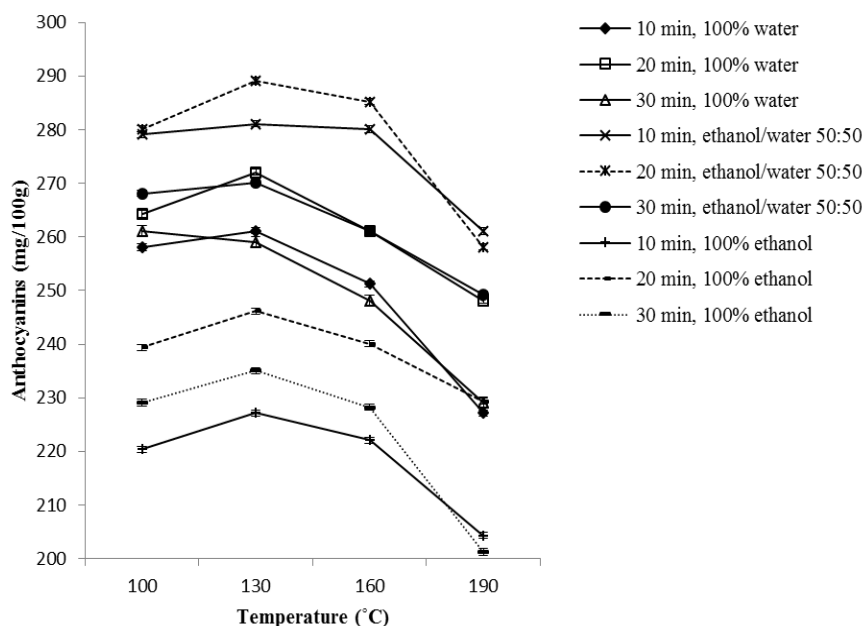

Figure 6. The effect of extraction temperature, time and ethanol/water ratio of SSE method on anthocyanins of PPEs.

increasing extraction temperature from 100 to 160°C, enhanced the TPCs and TFs significantly ($P < 0.05$). By increasing the temperature, the dielectric constant of solvent was considerably decreased and the solubility of phenolic compounds was increased

(Aliakbarian *et al.*, 2012). Increasing temperature could also promote the mass transfer of phenolic compounds by enhancing the diffusivity and decreasing the viscosity (Aliakbarian *et al.*, 2012). However, TPCs and TFs decreased at 190°C possibly due to the



degradation of some phenolic compounds and flavonoids (Cam and Hisil, 2010) and may react with other compounds (He *et al.*, 2012). It has been reported that the highest amount of gallic acid of winery by-products, has been achieved at 150°C and 1,500 psi (Garcia-Marino *et al.*, 2006). Singh and Saldana (2011) found that the solubility of phenolic acids such as gallic increased with enhanced temperature, but at temperatures higher than 180°C, the phenolic acid was degraded. It should be noted that optimum temperature for extraction of phenolic compounds by SSE method from several type of plants are different. Considering that the most important effect of higher temperature is related to the breaking of bonds between the solutes and the matrix, it seems that the solutes in some plants are more strongly bonded to the matrix (Plama *et al.*, 2001). For example, appropriate temperature for polyphenols extraction of dried grape skin and apple pomace was found at 110°C for 40 seconds (Ju and Howard, 2005) and 102°C for 5 minutes (Wijngaard and Brunton, 2009), respectively. However, best temperature for phenolic acid extraction of potato peel was obtained at 180°C for 60 minutes (Singh and Saldand, 2011).

Presence of 50% ethanol in extracting solvent could significantly enhance the amount of TPCs, TFs, and TACs compared with 100% water and 100% ethanol (Figures 3-6). Ethanol accelerates the extraction of phenolic compounds, probably because it denatures cellular membrane (Jackman *et al.*, 1987). It has been reported that the optimal superheated liquid extraction condition for total phenolics of red grape skins were 50:50 (v/v) ethanol-water acidified with 0.8% (v/v) HCl, 120°C, 30 minutes and 80 bar (Luque-Rodriquez *et al.*, 2007). In addition to water, hydroethanolic mixtures are the major liquids used in SSE of polyphenols from plants. Using two solvents could increase extraction yield since ethanol can improve the solubility of the solute, while water can assist in desorption of the solute from the matrix (Wijngaard *et al.*, 2012). Ethanol concentration in solvent of SSE has large effect on the extraction yield of polyphenols. The use of ethanol can affect the

polarity of the solvent and reduce the boiling point (Wijngaard and Brunton, 2009). According to Shang *et al.* (2014), 30-50% ethanol in solvent is helpful to improve the phenolic extraction.

Under the selected working conditions, 20 minutes were enough for maximum extraction of phenolic compounds and flavonoids. The amounts of TPCs and TFs decreased in long time and high temperature, probably because of denaturation of these compounds.

The maximum amount of anthocyanins was obtained at 130°C, 50% ethanol, and 20 minutes (Figure 6). It has been reported that anthocyanins of red grape skin were quantitatively extract at 120°C, in 20 minutes and without significant difference when ethanol in the extraction is between 40 and 60% (Luque-Rodriquez *et al.*, 2007). Monrad *et al.* (2010) reported degradation of anthocyanons in hydroethanolic solution at temperatures higher than 120°C. Anthocyanins are thermo- labile bioactive compounds, which can be degraded at relatively high temperature (Wijngaard *et al.*, 2012).

Solvent Extraction, Pretreated with DIC

DIC pretreatment was applied at different processing temperature and time on pomegranate peel. The recovered peels extracted by solvent ethanol:water 60:40 (25°C, 24 hours) and amount of phenolic compounds, flavonoids, anthocyanins and extraction yields of extracts are presented in Figure 7. According to Figure 7, there is an interaction between DIC time and temperature on TPCs, TFs, anthocyanins and extraction yield. At 110 and 130°C, by increasing the time of treatment, TPCs, TFs and anthocyanins content and extraction yield increased significantly ($P < 0.05$). At 150°C and 5 seconds, the maximum amount of phenolic compound, flavonoids, anthocyanins and extraction yield was achieved ($P < 0.05$). Rapid dropping of the pressure towards a vacuum state and instantaneous cooling of the products resulted in swelling and rupturing of

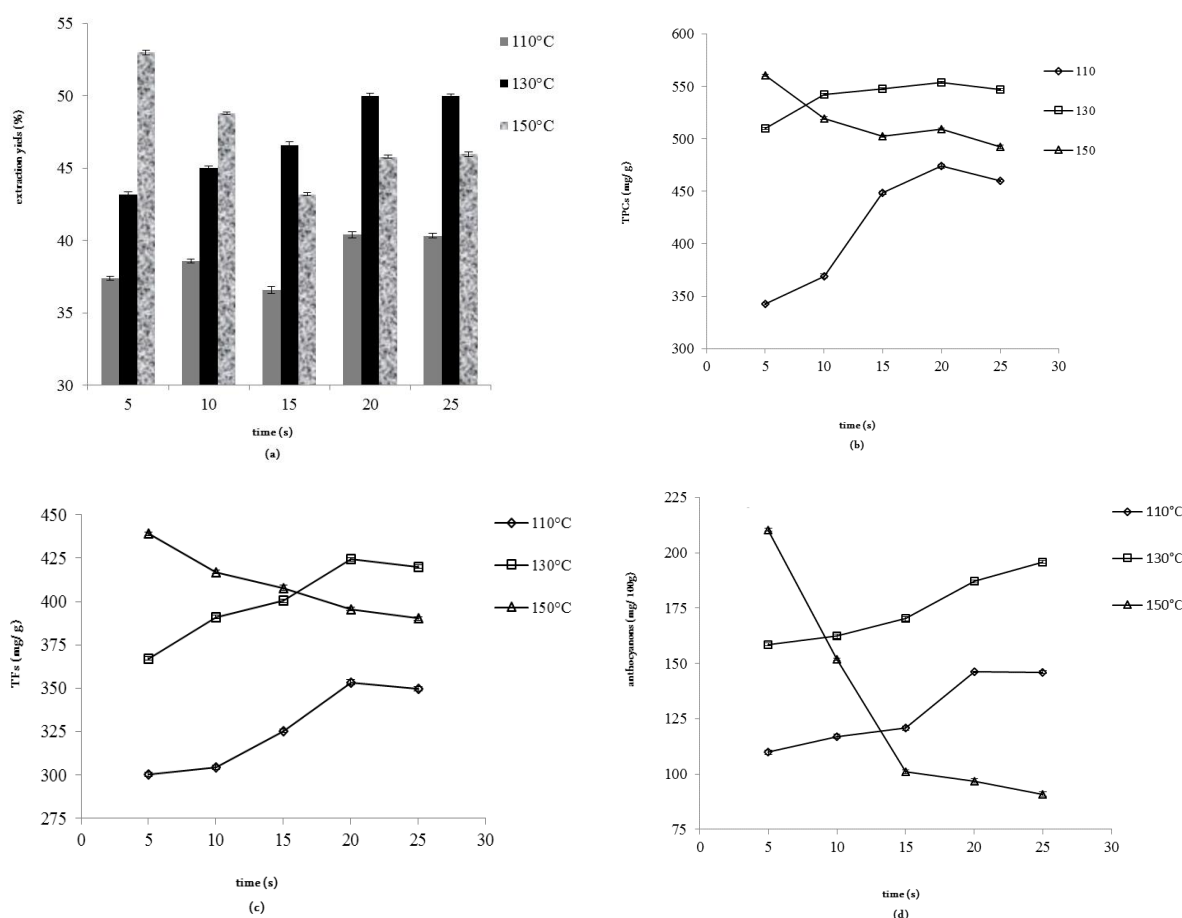

Figure 7. The effect of temperature and time of DIC pretreatment on extraction yield (a); TPCs (b); TFs (c), and anthocyanins (d) of PPEs

the cell walls. Pretreated samples had a porous structure and high specific surface area. Therefore, mass transfer becomes much higher. At low temperature (below 130°C), the pressure of the treating chamber is low and the steam penetration through the texture is not complete. Also, at low pressure, the instant pressure drop towards a vacuum state is not enough to create a porous structure in the pomegranate peel.

The amounts of TPCs, TFs, and TACs in DIC-SE sample (150°C, 5 seconds) were approximately 1.8, 2.4 and 2 fold, respectively, more than in the control samples (Table 1). Similar to our results, Allaf *et al.*, (2013a) reported that extraction yields of rosmarinic acid (rosemary antioxidant compound) from DIC treatment was twice as much as that in

untreated rosemary leaves. Ben-Amor and Allaf (2009) have also demonstrated that DIC pretreatment has a great impact on the kinetics and extraction yield of anthocyanins from the dried calyces of Roselle. DIC pretreatment had positive and significant effect on the extraction of different phenolic compounds from grape stalk powder by several types of solvent (Sanchez-Valdepenas *et al.*, 2015). Mkaouar *et al.*, (2015) reported that the total phenolic compounds yield of dry DIC-textured olive leaf was higher than that of untreated material. Natural structures of plants are very compact and resistant to penetration liquid in solvent extraction (Allaf *et al.*, 2013b). DIC pretreatment increases solvent penetration by creating pores in plants structure. According to Figure 7, at 150°C after 5 seconds, the amounts of TPCs, TFs, and TACs were

Table 1. Extraction yield, TPCs, TFs and TACs of extracts obtained by SSE, DIC-SE and conventional solvent extraction methods.^a

Method	Yield (%)	TPC (mg g ⁻¹)	TF (mg g ⁻¹)	TACs (mg 100 g ⁻¹)
Superheat solvent extraction	68.70±0.10 ^a	563.16±1.04 ^a	278.09±1.01 ^b	285.23±1.08 ^a
DIC assisted solvent extraction	53.00±0.08 ^b	460.54±0.03 ^b	439.07±0.05 ^a	250.05±1.60 ^b
Conventional solvent extraction	50.10±0.15 ^c	249.52±0.01 ^c	181.13±0.09 ^c	210.44±0.05 ^c

^a Values represent the mean±standard deviation (n= 3). Values with different superscript in columns are significantly different (P< 0.05).

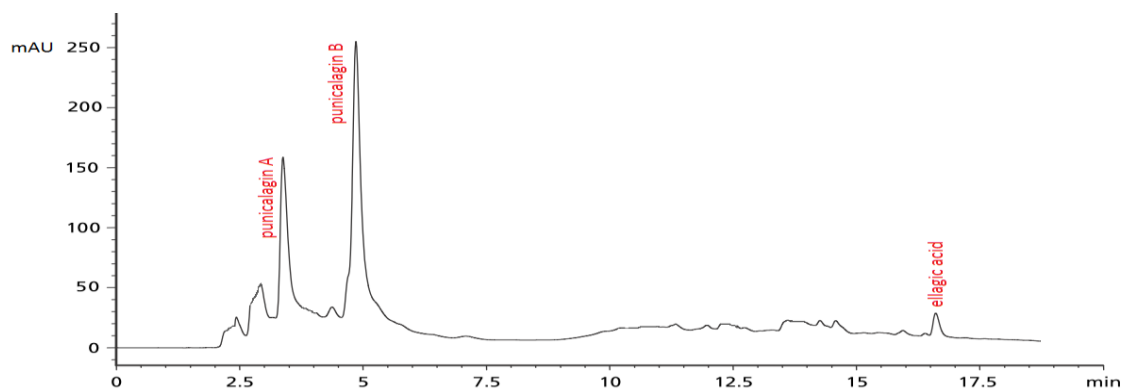

Figure 8. HPLC chromatogram of pomegranate peels extract.

reduced. This maybe due to decomposition of the phenolic compounds during higher temperature for a long thermal treating time. Similar to our results, Mkaouar *et al.*, (2015) reported that DIC thermal treatment for a longer time (more than 11 seconds) had negative effect on total phenolic content of olive leaf.

Comparison of SSE and DIC- SE Methods

We couldn't find a study about comparison of SSE with DIC-SE methods. But, our comparison results illustrated in Table 1 show that extraction yield, amount of TPCs and TACs in the best condition of extraction by SSE (160°C, 20 minutes and water:ethanol 50: 50 (P< 0.05) were significantly (P< 0.05) more than the best condition of DIC-SE method (150°C, 5 seconds). But TFs content of DIC-SE extract was significantly higher than SSE extract. High temperature of extraction process in SSE causes the higher release of phenolic compounds because of cellular deformation (Shang *et al.*, 2014). Durmaz and Gokmen (2011) reported that degradation of lignin had taken place in black bamboo leaves at high

temperature. Lignin conjugates with polysaccharides and proteins by ether and ester bonds. These bonds could be hydrolyzed by SSE at high temperatures and much more phenolic compounds released from the matrix (He *et al.*, 2012). Furthermore, some phenolic compounds are extracted at high temperature. Palma *et al.* (2001) demonstrated that in extraction of grape seed by SSE, some phenolic compounds were not detected at all in the extractions run at 50 and 100°C, but they were detected in the extraction obtained at 150°C.

Degradation process for phenolic compounds is an oxidative process that requires the presence of oxygen. Due to SSE was applied under nitrogen atmosphere, there were no degradation.

HPLC Analyses of Phenolic Compounds

Gallic acid, ellagic acid, punicalagin A and B of extracts obtained by SSE, DIC-SE and conventional solvent methods were quantified by HPLC (Table 2). Gallic acid was not detected in any of the extracts (Figure 8). However, a lot of studies showed that gallic

Table 2. HPLC analyzes of extracts obtained by SSE, DIC-SE and conventional solvent extraction methods.

Method	Retention time (Min)				Amount (mg g ⁻¹)			
	Gallic acid	Ellagic acid	Punicalagin A	Punicalagin B	Gallic acid	Ellagic acid	Punicalagin A	Punicalagin B
Superheated solvent extraction	nd ^a	16.840	3.50	5	nd	0.296	1.61	2.565
DIC assisted solvent extraction	nd	17.123	3.84	5.340	nd	1.130	6.121	9.793
Conventional solvent extraction	nd	16.837	3.51	4.971	nd	0.274	1.484	2.375

^a nd: Not detected.

acid was one of the main phenolic compounds of pomegranate peel (Qu *et al.*, 2012). But, in Sawant and Chavan (2013) study, amount of gallic acid in methanolic extract of pomegranate peel was very low (0.01-0.06 mg L⁻¹). Ellagic acid content of the obtained extracts by three methods was between 0.274-1.13 mg g⁻¹ (Table 2). According to Gullon *et al.* (2016) findings, punicalagin and ellagic acid are two important phenolic compounds of pomegranate peel. In their study, the amount of ellagic acid was 0.15 mg g⁻¹. Akhavan *et al.* (2015) reported that the amount of ellagic acid was 121.2-928.3 mg L⁻¹ in the whole pomegranate juice from ten Iranian cultivars. They also reported that gallic acid was found in a minor amount.

According to Table 2, punicalagin A and B were the major phenolic compounds in pomegranate peel extracts. In Akhavan *et al.* (2015) study, punicalagin A and B were the most important phenolic compounds in Iranian pomegranate juice and their amounts in whole pomegranate juice were between 23.3- 285 and 132.8- 884.3 mg L⁻¹, respectively. Gullon *et al.* (2016) reported that punicaldgin with retention time of 6.45 min was 16.67 mg g⁻¹ dry matter in pomegranate peel dry flour.

The amount of ellagic acid, punicalagin A and B in the extract obtained by DIC-SE method (150°C, 5 seconds) were higher than the other two methods used (Table 2). Phenolic compounds divided in two main groups: flavonoids and non-flavonoids. Flavonoids are based upon a fifteen-carbon skeleton consisting of two benzene rings (A and B) linked via a heterocyclic pyrane ring

(C) Flavonoids have the C6-C3-C6 general structural backbone in which the two C6 units (rings A and B) are of phenolic nature. Due to the hydroxylation pattern and variation in the chromane ring (ring C), flavonoids can be divided into different sub groups such as flavones, flavonols, flavonones, and anthocyanins. Simple phenols, phenolic acids, and hydroxyl cinnamic acids are in group of non-flavonoids. According to this classification, ellagic acid and punicalagin are flavonoid. As results showed (Table 1), amount of TFs in extract obtained by DIC-SE (150°C, 5 seconds) was higher than SSE (160°C, 20 minutes and water:ethanol 50: 50) and the conventional solvent extraction methods which match the HPLC results (Table 2). Therefore, we could conclude that, even though SSE is a good method for extraction of TPCs from pomegranate peel, when the extraction of flavonoids of pomegranate peel is considerable, the DIC-SE method is better.

CONCLUSIONS

The highest amount of TPCs, TFs, TACs and extraction yields by SSE was achieved at 160°C, ethanol:water 50:50, and 20 minutes (P< 0.05). The best DIC pretreatment for extraction of TPCs, TFs, TACs and highest extraction yields was 150°C for 5 seconds (P< 0.05). DIC could extract high amounts of phenolic compounds compared with conventional extraction method (control sample). SSE method, in the best condition, had higher extraction yield than DIC



pretreatment (in the best condition). TPCs and TACs content in extract obtained by SSE was more than DIC pretreatment. But, TFs amount of DIC pretreatment method was higher. Conclusively, SSE is not only an environmentally friendly technology but also a high efficient method for the extraction of TPCs and TACs from pomegranate peel. Also, DIC is an interesting pretreatment for extraction of flavonoids.

REFERENCES

1. Akhavan, H., Barzegar, M., Weidlich, H. and Zimmermann, B. F. 2015. Phenolic Compounds and Antioxidant Activity of Juice from Ten Iranian Pomegranate Cultivars Depend on Extraction. *J. Chem.*, 1-7.
2. Aliakbarian, B., Fathi, A., Perego, P. and Deghani, F. 2012. Extraction of Antioxidant from Winery Wastes Using Subcritical Water. *J. Supercrit. Fluid.*, **65**: 18-24.
3. Allaf, T., Tomao, V., Ruiz, K., Bachari, K., ElMaataoui, M. and Chemat, F. 2013a. Deodorization by Instant Controlled Pressure Drop Autovaporization of Rosemary Leaves Prior to Solvent Extraction of Antioxidants. *Food Sci. Technol.*, **51**: 111-119.
4. Allaf, T., Tomao, V., Ruiz, K. and Chemat, F. 2013b. Instant Controlled Pressure Drop Technology and Ultrasound Assisted Extraction for Sequential Extraction of Essential Oil and Antioxidants. *Ultrason. Sonochem.*, **20**: 239-246.
5. Ben-Amor, B. and Allaf, K. 2009. Impact of Texturing Using Instant Pressure Drop Treatment Prior to Solvent Extraction of Anthocyanins from Malaysian Roselle (*Hibiscus sabdariffa*). *Food Chem.*, **115**: 820-825.
6. Blasa, M., Candiracci, M., Accorsi, A., Piacentini, P. M., Albertini, M. C. and Piatti, E. 2005. Raw Milleforihoney is Packed Full of Antioxidants. *Food Chem.*, **9**: 217-222.
7. Çam, M. and Hisil, Y. 2010. Pressurised Water Extraction of Polyphenols from Pomegranate Peels. *Food Chem.*, **123**: 878-885.
8. Cam, M., Icyer, N.C. and Erdogan, F. 2014. Pomegranate Peel Phenolics: Microencapsulation, Storage Stability and Potential Ingredient for Functional Food Development. *Food Sci. Technol.*, **55(1)**: 117-123.
9. Cheng, G. W. and Breen, P. J. 1991. Activity of Phenylalanine Ammonialyase (PLA) and Concentration of Anthocyanins and Phenolics in Developing Strawberry Fruit. *J. Am. Soc. Hort. Sci.*, **116**: 865-869.
10. Durmaz, G. and Gokmen, V. 2011. Changes in Oxidative Stability, Antioxidant Capacity and Phytochemical Compositions of *Pistaciaterebinthus* Oil with Roasting. *Food Chem.*, **128**: 410-414.
11. Garcia- Marino, M., Rivas- Gonzalo, J.C., Ibanez, E., Garcia- Moreno, C. 2006. Recovery of Catechins and Proanthocyanidins from Winery by-Products Using Subcritical Water Extraction. *Analytica Chimica Acta*, **563**: 44-50.
12. Gullon, B., Pintado, M. E., PerezAlvarez, J. and Viuda-Martos, M. 2016. Assessment of Polyphenolic Profile and Antibacterial Activity of Pomegranate Peel (*Punica granatum*) Flour Obtained from Co-Product of Juice Extraction. *Food Control*, **59**: 94-98.
13. He, L., Zhang, X., Xu, H., Xu, Ch., Yuan, F., Knez, K., Novak, Z. and Gao, Y. 2012. Subcritical Water Extraction of Phenolic Compounds from Pomegranate (*Punica granatum L.*) Seed Residues and Investigation into Their Antioxidant Activities with HPLC-ABTS. *Food. Bioprod. Process.*, **90**: 215-223.
14. Jackman, R. L., Yada, R. Y., Tung, M. A. and Speers, R. A. 1987. Anthocyanins as Food Colorants: A Review. *J. Food. Biochem.*, **11**: 201-247.
15. Japon-Lujan, R. and Luque de Castro, M. D. 2006. Superheated Liquid Extraction of Oleuropein and Related Biophenols from Olive Leaves. *J. Chromatogr. A.*, **1136**: 185-191.
16. Ju, Z. Y. and Howard, L. R. 2003. Effects of Solvent and Temperature on Pressurized Liquid Extraction of Anthocyanins and Total Phenolics from Dried Red Grape Skin. *J. Agric. Food Chem.*, **51(18)**: 5207-5213.
17. Ju, Z. Y. and Howard, L. R. 2005. Subcritical Water and Sulfured Water Extraction of Anthocyanins and Other Phenolics from Dried Red Grape Skin. *J. Food Sci.*, **70**: 270-276.

18. Luque-Rodriguez, J. M., Luque de Castro, M. D. and Perez-Juan, P. 2007. Dynamic Superheated Liquid Extraction of Anthocyanins and Other Phenolics from Red Grape Skins of Winemaking Residues. *Bioresour. Technol.*, **98(14)**: 2705–2713.
19. Mansour, E., Ben Khaled, A., Lachiheb, B., Abid, M., Bachar, Kh. and Ferchichi, A. 2013. Phenolic Compounds, Antioxidant, and Antibacterial Activities of Peel Extract from Tunisian Pomegranate. *J. Agr. Sci. Tech.*, **15**: 1393- 1403.
20. Mkaouar, S., Bahloul, N., Gelicus, A., Allaf, K. and Kechaou, N. 2015. Instant Controlled Pressure Drop Texturing for Intensifying Ethanol Solvent Extraction of Olive (*Olea europaea*) Leaf Polyphenols. *Sep. Purif. Technol.*, **145**: 139-146.
21. Monrad, J. K., Howard, L. R., King, J. W., Srinivas, K. and Mauromoustakos, A. 2010. Subcritical Solvent Extraction of Anthocyanins from Dried Red Grape Pomace. *J. Agri. Food Chem.*, **58(5)**: 2862–2868.
22. Palma, M., Pinerio, Z. and Barroso, C. 2001. Stability of Phenolic Compounds during Extraction with Superheated Solvents. *J. Chromatogr. A.*, **921(2)**: 169-174.
23. Qu, W., Breksa, A., Pan, Zh. and Ma, H. 2012. Quantitative Determinate of Major Polyphenol Constituents in Pomegranate Products. *Food Chem.*, **132**: 1585- 1591.
24. Rahnemoon, P., Sarabi Jamab, M., Javanmard Dakheli, M. and Bostan, A. 2017. Evaluation of Extraction Condition on Phenolic Compounds and Antimicrobial Properties of Pomegranate (*Punica Granatum*) Peels. *J. Food Sci. Technol.*, **65(14)**.
25. Sadeghi, N., Jannat, B., Oveisi, M. R., Hajimahmoodi, M. and Photovat, M. 2009. Antioxidant Activity of Iranian Pomegranate (*Punica Granatum*L.) Seed Extracts. *J. Agr. Sci. Tech.*, **11**: 633- 368.
26. Sanchez-Valdepenas, V., Barrajon, E., Vegara, S., Funes, L., Marti, N., Valero, M. and Saura, D. 2015. Effect of Instant Controlled Pressure Drop (DIC) Pre-Treatment on Conventional Solvent Extraction of Phenolic Compounds from Grape Stalk Powder. *Ind. Crop. Prod.*, **76**: 545-549.
27. Sawant, N. R. and Chavan, A. R. 2013. Determination of Gallic Acid from Their Methanolic Extract of *Punica granatum* by HPLC Method. *Int. J. Chem. Tech. Res.*, **5**: 2598- 2602.
28. Shang, Y. F., Kim, S. M., Song, D. G., Pan, C. H., Lee, W. J. and Um, B. H. 2010. Isolation and Identification of Antioxidant Compounds from *Ligularia fischeri*. *J. Food. Sci.*, **75(6)**: 530–535.
29. Shang, Y. F., Kim, S. M. and Um, B. H. 2014. Optimization of Pressurized Liquid Extraction of Antioxidants from Black Bamboo Leaves. *Food Chem.*, **154**: 164–170.
30. Sharifi, A., Mortazavi, S.A., Maskooki, A., Niakousari, A. and Elhamirad, A. H. 2013. Optimization of Subcritical Water Extraction of Bioactive Compounds from Barberry Fruit (*Berberis vulgaris*) by Using Response Surface Methodology. *Int. J. Agric. Crop Sci.*, **6(2)**: 89-96.
31. Singh, P. P. and Saldaña, M. D. A. 2011. Subcritical Water Extraction of Phenolic Compounds from Potato Peel. *Food. Res. Int.*, **44(8)**: 2452–2458.
32. Singleton, V., Orthofer, R. and Raventos, R. 1999. Analysis of Total Phenols and Other Oxidation Substrates and Antioxidants by Mean of Folin-Ciocalteu Reagent. *Method. Enzymol.*, **299**: 152- 178.
33. Wijngaard, H. and Brunton, N. 2009. The Optimization of Extraction of Antioxidants from Apple Pomace by Pressurized Liquids. *J. Agric. Food Chem.*, **57(22)**: 10625–10631.
34. Wijngaard, H., Hossain, M.B., Rai, D. K. and Brunton, N. 2012. Technique to Extract Bioactive Compounds from By-Products of Plant Origin. *Food. Res. Int.*, **46**: 505-513.
35. Yasoubi, P., Barzegar, M., Sahari, M. A. and Azizi, M. H. 2007. Total Phenolic Contents and Antioxidant Activity of Pomegranate (*Punica granatum L.*) Peel Extracts. *J. Agr. Sci. Tech.*, **9**: 35-42



مقایسه روش‌های استخراج با حلال فوق داغ و افت فشار کنترل شده قبل از استخراج با حلال در استخراج ترکیبات فنولی از پوست انار

پ. رهنمون، م. سرابی جماب، م. جوانمرد داخلی، ع. بستان، و ا. صفری

چکیده

در این مطالعه، تاثیر دو روش استخراج با حلال فوق داغ و استخراج با حلال -پیش تیمار شده با DIC- بر مقدار ترکیبات فنولی، فلاونوئیدها و آنتوسیانین‌های عصاره پوست انار مورد بررسی قرار گرفت. پارامترهای متغیر در روش استخراج با حلال فوق داغ، دما، زمان و نسبت اتانول: آب و در روش استخراج با حلال- پیش تیمار شده با DIC- دما و زمان حرارت‌دهی بود. بالاترین میزان بازدهی استخراج و بیشترین مقدار ترکیبات فنولی و فلاونوئیدها در روش استخراج با حلال فوق داغ در دمای ۱۶۰ درجه سانتی‌گراد، زمان ۲۰ دقیقه و نسبت اتانول: آب ۵۰:۵۰ بدست آمد ($p < 0.05$). همچنین پیش تیمار DIC، در دمای ۱۵۰ درجه سانتی‌گراد و زمان ۵ ثانیه بیشترین تاثیر را در افزایش میزان بازدهی استخراج، مقدار ترکیبات فنولی، فلاونوئیدها و آنتوسیانینها داشت ($p < 0.05$). در روش استخراج با حلال فوق داغ، مقدار ترکیبات فنولی کل ($1.04 \pm 563/16$ میلی‌گرم در گرم) و آنتوسیانینها ($1.02 \pm 285/11$ میلی‌گرم در گرم) و نیز مقدار بازدهی استخراج ($7/68\%$) نسبت به روش استخراج با حلال- پیش تیمار شده با DIC- بالاتر بود. درحالیکه مقدار فلاونوئیدهای استخراج شده از پوست انار با روش استخراج با حلال- پیش تیمار شده با DIC- بیشتر بود ($0.05 \pm 439/07$ میلی‌گرم در گرم). بر اساس نتایج حاصل از کروماتوگرافی با کارایی بالا، مقدار الازیک اسید و پونیکالاجین A و B در عصاره استخراج شده با حلال -پیش تیمار شده با DIC- بیشتر از نمونه استخراج شده با حلال فوق داغ بود. گالیک اسید در هیچ یک از نمونه‌ها شناسایی نشد. این مطالعه نشان داد که استخراج با حلال فوق داغ یک روش موثر در استخراج ترکیبات فنولی و DIC یک پیش تیمار سودمند برای استخراج فلاونوئیدها از پوست انار می‌باشد.